

ROTAX
NEW AGE KARTING



ERSATZTEILE LISTE SPARE PARTS LIST

FÜR ROTAX MOTOR
FOR ROTAX ENGINE

TYPE 125 MAX DD2
Inklusive Hinterreifen Sicherheitssystem
Including rear tire protection system

PRODUKTION / PRODUCTION: 2012

AUSFÜHRUNG / CONFIGURATION: 31.0125.200

NR. / NO.: 1471

AUSGABE / EDITION: 01 2012

BRP-Powertrain GmbH & Co KG
Welser Straße 32
A-4623 Gunskirchen, Austria
T: +43 7246 601 0 F: +43 7246 6370

www.rotax.com
www.kart-rotax.com
www.maxchallenge-rotax.com
www.mojo-tyres.com

NUR ZUR INFORMATION.
ÄNDERUNSDIENST NICHT VORGESEHEN.
FOR INFORMATION ONLY.
WITHOUT COMMITMENT TO ADVISE MODIFICATIONS.

BRP-Powertrain empfiehlt Produkte der Marken:

BRP-Powertrain recommends products of following brands:

 **MOJO**[®]

 **XPS**[®]
KART TEC







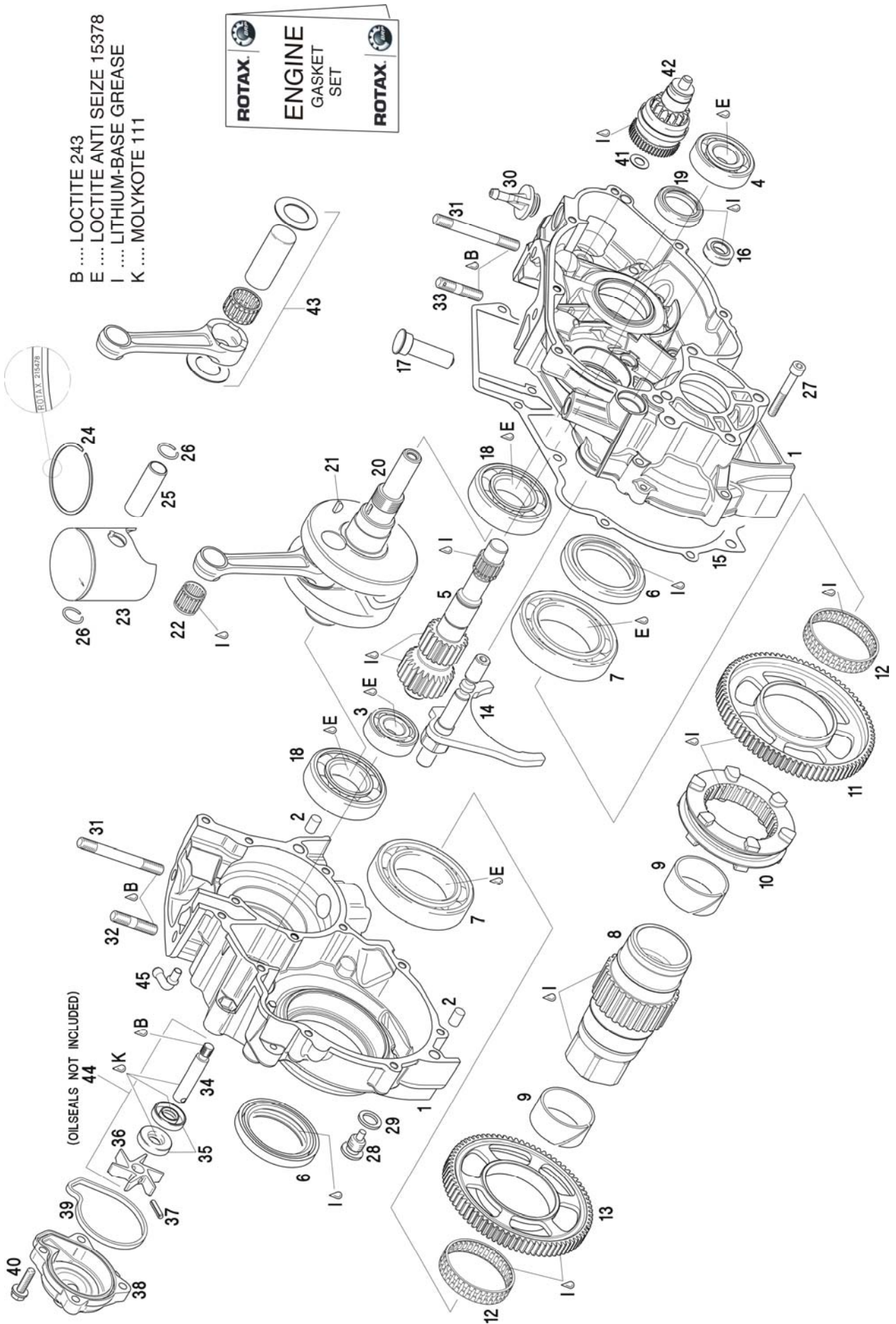







INHALTSVERZEICHNIS TABLE OF CONTENTS















KAPITEL/CHAPTER	SEITE/PAGE
1. KURBELGEHÄUSE, KURBELWELLE, KOLBEN, GETRIEBE, E-STARTER TRIEB CRANKCASE, CRANKSHAFT, PISTON, GEARBOX, E-STARTER DRIVE	5
2. ZYLINDER CYLINDER	11
3. FLIEHKRAFTKUPPLUNG, AUSGLEICHSTRIEB, PRIMÄRTRIEB, KUPPLUNGSDECKEL CENTRIFUGAL CLUTCH, BALANCE SHAFT DRIVER, PRIMARY DRIVE, CLUTCH COVER	17
4. ABTRIEB, SCHALTUNG, SCHALTSEILZÜGE, LENKRADNABE POWER TAKE OFF, SHIFTING, SHIFTING BOWDEN CABLES, STEERING WHEEL HUB	21
5. ZÜNDANLAGE, E-STARTER, BATTERIE, BATTERIEDECKEL, LADEGERÄT, KABELBAUM IGNITION UNIT, E-STARTER, BATTERY, BATTERY COVER, BATTERY CHARGER, CABLE HARNESS	27
6. VERGASER, DICHTUNGSSATZ (VERGASER), KRAFTSTOFFPUMPE, REPARATURSATZ (KRAFTSTOFFPUMPE), KRAFTSTOFFSCHLAUCH, GASSEILZUG CARBURETTOR, GASKET SET (CARBURETTOR), FUEL PUMP, REPAIR SET (FUEL PUMP), FUEL TUBE, CABLE BOWDEN	33
7. KÜHLER, KÜHLERBEFESTIGUNG RADIATOR, RADIATOR MOUNTING	39
8. ANSAUGGERÄUSCHDÄMPFER, DÄMPFERFILTER INTAKE SILENCER, FILTER ELEMENT	41
9. AUSPUFFANLAGE EXHAUST SYSTEM	43
10. WERKZEUGE REPAIR TOOLS	47
11. SERVICE PRODUKTE SERVICE PRODUCTS	51
12. HINTERREIFEN SICHERHEITS SYSTEM REAR TIRE PROTECTION SYSTEM	55
13. ZUBEHÖR & XPS®-PRODUKTE ACCESSORIES & XPS®-PRODUCTS	57

























Chapter 1

**KURBELGEHÄUSE, KURBELWELLE, KOLBEN, GETRIEBE, E-STARTER TRIEB
CRANKCASE, CRANKSHAFT, PISTON, GEARBOX, E-STARTER DRIVE**

BILD-NR. ILL.NO.	TEILE-NR. PART-NO.	BEZEICHNUNG DESCRIPTION	STÜCK QTY.	BARCODE BAR CODE
1-2	684 233	GEHAEUSE KPL. CRANKCASE ASSY. USED FOR OLD AND NEW PADDLE SHIFT SYSTEM	1	
2	632 010	ZYLINDERROLLE 8X12 DIN 5402 PIN 8X12 DIN 5402	2	
3	932 030	RK-LAGER 6203 C3 BALL BEARING 6203 C3, 17-40-12	1	
4	932 432	RK-LAGER 6204 C3 BALL BEARING 6204 C3, 20-47-14	1	
5	N 620 182	VORGELEGEWELLE 24/19 Z PRIMARY SHAFT 24/19 T	1	
6	630 500	WD-RING ASL 50X68X8 NBR OIL SEAL ASL 50X68X8 NBR	2	
7	432 330	RK-LAGER 6010 C3 B. BEARING 6010 C3 50-80-16	2	
8	620 164	HOHLWELLE HOLLOW SHAFT	1	
9	233 120	LAGERHUELSE 40X44X20 PLAIN BEARING 40X44X20	2	
10	257 362	SCHALTMUFFE SHIFTING SLEEVE	1	
11	635 702	LOSRAD 81 Z IDLE GEAR 81 T 1. GANG 1. GEAR	1	
12	632 665	NADELKAEFIG K 52X57X12 NEEDLE BEARING K 52X57X12	2	
13	635 712	LOSRAD 77 Z IDLE GEAR 77 T 2. GANG 2. GEAR	1	

14		257 405	SCHALTGABEL KPL. SHIFT FORK ASSY.	1	
15		630 522	DICHTUNG GASKET	1	
16		250 455	WD-RING AS 12X22X7 NBR OIL SEAL 12X22X7	1	
17		257 422	SCHALTSTANGENARRETIERUNG SHIFT RAIL DETENT PIN	1	
18		832 533	RK-LAGER 6206 TVH C4M BALL BEARING 6206 TVH C4M 30-62-16	2	
19		930 695	WD-RING AS 30X42X7/7,5 NBR OIL-SEAL AS 30X42X7/7,5 NBR	1	
20		685 010	KURBELWELLE KPL. CRANKSHAFT ASSY.	1	
21		246 015	SCHEIBENFEDER 3X5 DIN 6888 WOODRUFF KEY 3X5	1	
22		932 026	KOLBENBOLZENKAEFIG K 15X19X20 NEEDLE CAGE K 15X19X20	1	
23-24	N	296 297	KOLBEN KPL. 53,97 MM PISTON ASSY. 53,97 MM STANDARD	1	
23-24	N	296 298	KOLBEN KPL. 53,98 MM PISTON ASSY. 53,98 MM STANDARD	1	
23-24	N	296 296	KOLBEN KPL. 53,99 MM PISTON ASSY. 53,99 MM ÜBERMASS OVERSIZE	1	
23-24	N	296 299	KOLBEN KPL. 54,00 MM PISTON ASSY. 54,00 MM ÜBERMASS OVERSIZE	1	
24	N	215 548	R-RING IS2-54/49,4X1 RECTANGULAR RING IS2-54/49,4X1	1	
25		216 135	KOLBENBOLZEN 15X10/12X45,6 PISTON PIN 15X10/12,5X45,6	1	

26	945 635	NULLHAKENRING 15 CIRCLIP 15 NUR EINMAL VERWENDEN USE ONLY ONCE	2	
27	241 821	ZYL.SCHRAUBE M6X45 DIN 912 ALLEN SCREW M6X45 DIN 912 ANZUGSDREHMOMENT 10 NM TIGHTENING TORQUE 10 NM	12	
28	241 783	MAGNETSCHRAUBE M12X1,5 MAGNETIC DRAIN PLUG M12X1,5 ANZUGSDREHMOMENT 20 NM TIGHTENING TORQUE 20 NM	1	
29	250 640	DICHTRING A 12X18 DIN 7603 SEALING RING A 12X18-CU DIN 7603	1	
30	241 925	ENTLUEFTUNGSSCHRAUBE M18X1,5 AIR VENT SCREW M18X1,5	1	
31	940 786	STIFTSCHRAUBE M8X57/20 STUD M8X57/20 ANZUGSDREHMOMENT 5 NM TIGHTENING TORQUE 5 NM	2	
32	241 381	STIFTSCHRAUBE M8X28/20 STUD M8X28/20 ANZUGSDREHMOMENT 5 NM TIGHTENING TORQUE 5 NM	1	
33	241 386	STIFTSCHRAUBE M8X28/20 STUD M8X28/20 ANZUGSDREHMOMENT 5 NM TIGHTENING TORQUE 5 NM MIT BOHRUNG, ZUM VERSIEGELN DES MOTORS WITH HOLE, FOR SEALING OF THE ENGINE	1	
34		WASSERPUMPENWELLE PUMP SHAFT ACHTUNG: LINKSGEWINDE ATTENTION: LEFT HAND THREAD VERWENDE WASSERPUMPENWELLE KPL. 620275 USE WATERPUMP SHAFT ASSY. 620275	1	
35	230 195	WD-RING A 10X26X7 NBR OIL SEAL A 10X26X7 NBR	2	
36		LAUFRAD IMPELLER VERWENDE WASSERPUMPENWELLE KPL. 620275 USE WATERPUMP SHAFT ASSY. 620275	1	

37		SPANNHUELSE 4X16 A2 DIN 1481 SLOTTED SPRING PIN A2 4X16 VERWENDE WASSERPUMPENWELLE KPL. 620275 USE WATERPUMP SHAFT ASSY. 620275	1	
38	222 720	WASSERPUMPENGEHAEUSE WATER PUMP HOUSING	1	
39	630 770	SCHLAUCHRING 61,5X1,5X3,5 RUBBER RING 61,5X1,5X3,5	1	
40	941 250	TAPTITE-SCHRAUBE M6X20 TAPTITE-SCREW M6X20 ANZUGSDREHMOMENT 10 NM TIGHTENING TORQUE 10 NM	4	
41	227 945	ANLAUFSCHEIBE 8,5/15/0,5 THRUST WASHER 8,5/15/0,5	1	
42	294 810	STARTERGETRIEBE KPL. STARTER REDUCTION GEAR ASSY.	1	
43	295 879	KURBELWELLENSATZ CRANKSHAFT REPAIR KIT	1	
44	620 275	WASSERPUMPENWELLE KPL. WATERPUMP SHAFT ASSY. WD-RINGE 230195 NICHT ENTHALTEN OIL SEALS 230195 NOT INCLUDED	1	
45	924 523	IMPULSKRUEMMER IMPULSE FITTING	1	
46	296 162	DICHTUNGSSATZ GASKET SET ASSY.	1	
47	281 855	UMRUESTSATZ GETRIEBE 125 MAX DD2 RETROFIT KIT GEARBOX 125 MAX DD2	1	
E	297 434	LOCTITE ANTI SEIZE 15378 50 ML.	AS REQ.	
I	897 330	LITHIUM-BASE GREASE, 250 GR.,	AS REQ.	
K	897 161	MOLYKOTE 111, 100 GR	AS REQ.	
B	897 651	LOCTITE 243 BLUE, 10 CC.	AS REQ.	





- B LOCTITE 243
- C LOCTITE 648
- Q SILASTIC 732 RTV





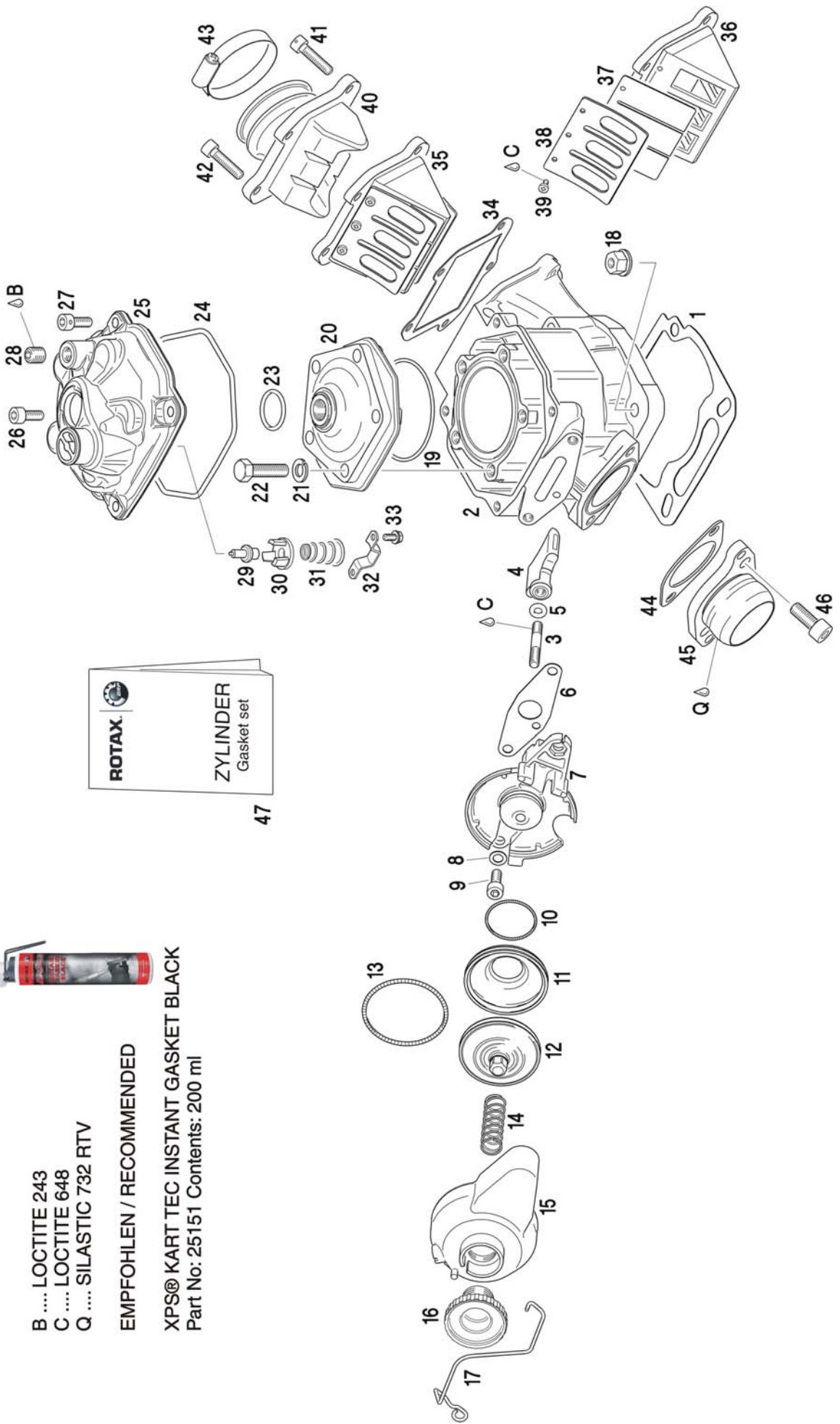







EMPFOHLEN / RECOMMENDED















XPS® KART TEC INSTANT GASKET BLACK
Part No: 25151 Contents: 200 ml

























Chapter 2

**ZYLINDER
CYLINDER**

BILD-NR. ILL.NO.	TEILE-NR. PART-NO.	BEZEICHNUNG DESCRIPTION	STÜCK QTY.	BARCODE BAR CODE
1	431 337	DICHTUNG 0,2 GASKET 0,2 MM GASKET FOR RACING PURPOSE ONLY TO ENSURE PROPER SEALING PLEASE USE SILICONE COMPOUND GREASE 897061	N. BED. AS REQ.	
1	650 480	DICHTUNG 0,3 GASKET 0,3 MM	N. BED. AS REQ.	
1	650 483	DICHTUNG 0,4 GASKET 0,4 MM	N. BED. AS REQ.	
1	650 481	DICHTUNG 0,5 GASKET 0,5 MM	N. BED. AS REQ.	
1	650 482	DICHTUNG 0,8 GASKET 0,8 MM	N. BED. AS REQ.	
2	613 933	ZYLINDER NI SI C BESCHICHTET CYLINDER NI SI C PLATED A: 54,000 - 54,010 MM AB: 54,010 - 54,015 MM B: 54,015 - 54,025 MM	1	
3	441 355	STIFTSCHRAUBE M6X45,5 STUD M6X45,5 ANZUGSDREHMOMENT 2-3 NM TIGHTENING TORQUE 2-3 NM	1	
4	253 725	AUSLASSSCHIEBER EXHAUST VALVE	1	
5	230 260	O-RING DIN 3771-6X3-N, NBR 70 O-RING 6X3	1	
6	250 231	DICHTUNG GASKET	1	
7	253 380	SCHIEBERSTANGENFUEHRUNG VALVE ROD HOUSING	1	
8	845 020	FEDERSCHEIBE B6 DIN 137 SPRING WASHER B6	2	

9	241 236	ZYL.SCHRAUBE M6X16 DIN 912 GLATT ALLEN SCREW M6X16 DIN 912 ANZUGSDREHMOMENT 10 NM TIGHTENING TORQUE 10 NM	2	
10	838 255	SCHLAUCHFEDER 70-1,7-0,3 HOSE SPRING 70-1,7-0,3	1	
11	260 723	SCHIEBERBALG BELLOW	1	
12	854 440	SCHIEBERKOLBEN EXHAUST VALVE PISTON	1	
13	939 280	SCHLAUCHFEDER 134-3,0-0,65 HOSE SPRING 134-3,0-0,65	1	
14	239 940	DRUCKFEDER DM13,2 D0,8 L48,5 COMPRESSION SPRING 48,5/0,8 MM GELB MARKIERT YELLOW MARKED	1	
15	210 331	SCHIEBERABDECKUNG VALVE COVER	1	
16	641 890	EINSTELLSCHRAUBE ADJUSTMENT SCREW ZUR MANUELLEN VERSTELLUNG FOR MANUAL ADJUSTMENT	1	
17	239 030	FEDERBUEGEL SPRING CLIP	1	
18	242 706	BUNDMUTTER M8 COLLAR NUT M8 ANZUGSDREHMOMENT 24 NM TIGHTENING TORQUE 24 NM	4	
19	250 160	O-RING DIN 3771-64X2-N, FPM 75 O-RING 64X2	1	
20	223 385	BRENNRAUMEINSATZ COMBUSTION CHAMBER INSERT	1	
21	945 752	FEDERRING DIN 128-A8-FST LOCK WASHER A8	5	
22	940 487	SK-SCHRAUBE M8X30 DIN 933, 10.9 HEX.SCREW M8X30 DIN 933, 10.9 ANZUGSDREHMOMENT 30 NM TIGHTENING TORQUE 30 NM	5	

23	430 782	O-RING DIN 3771-23,3X2,4-N, MVQ 60 O-RING DIN 3771-23,3X2,4-N, MVQ 60	1	
24	250 280	O-RING DIN 3771-105X2,5-N, NBR 70 O-RING 105X2,5	1	
25	613 101	ZYLINDERKOPFDECKEL CYLINDER HEAD COVER	1	
26	241 236	ZYL.SCHRAUBE M6X16 DIN 912 GLATT ALLEN SCREW M6X16 DIN 912 ANZUGSDREHMOMENT 10 NM TIGHTENING TORQUE 10 NM	3	
27	641 361	ZYL.SCHRAUBE M6X25 ALLEN SCREW M6X25 ANZUGSDREHMOMENT 10 NM TIGHTENING TORQUE 10 NM MIT BOHRUNG, ZUM VERSIEGELN DES MOTORS WITH HOLE, FOR SEALING OF THE ENGINE	1	
28	240 480	VERSCHLUSSSCHRAUBE 1/8-27NPT PLUG SCREW 1/8-27NPT ANZUGSDREHMOMENT 10 NM TIGHTENING TORQUE 10 NM	1	
29	222 125	THERMOSTAT 45 GRAD THERMOSTAT, 45 DEGR.	1	
30	222 175	VENTILTELLER THERMOSTAT HOLDER	1	
31	239 950	DRUCKFEDER COMPRESSION SPRING	1	
32	222 202	THERMOSTATBUEGEL THERMOSTAT RETAINING BRACKET	1	
33	240 195	TAPTITE-SCHRAUBE M4X8 TAPTITE-SCREW M4X8 ANZUGSDREHMOMENT 3 NM TIGHTENING TORQUE 3 NM	2	
34	250 521	DICHTUNG GASKET	1	
35-39	224 389	VENTILTRAEGER KPL. REED VALVE ASSY.	1	

36		VENTILTRÄGER NICHT ALS ERSATZTEIL ERHÄLTlich, VENTILTRÄGER KPL. 224389 VERWENDEN! REED VALVE, NOT AVAILABLE AS REPLACEMENT PART, USE REED VALVE ASSY. 224389!		
37	224 430	BLATTVENTIL REED PETAL	2	
38		VENTILANSCHLAG NICHT ALS ERSATZTEIL ERHÄLTlich, VENTILTRÄGER KPL. 224389 VERWENDEN! REED PEDAL STOP, NOT AVAILABLE AS REPLACEMENT PART, USE REED VALVE ASSY. 224389!		
39	240 351	LINSENSCHRAUBE M3X6 DIN 7985 OVAL HEAD SCREW M3X6 DIN 7985	6	
40	267 410	ANSAUGSTUTZEN INTAKE SOCKET	1	
41	641 361	ZYL.SCHRAUBE M6X25 ALLEN SCREW M6X25 ANZUGSDREHMOMENT 6 NM TIGHTENING TORQUE 6 NM MIT BOHRUNG, ZUM VERSIEGELN DES MOTORS WITH HOLE, FOR SEALING OF THE ENGINE	1	
42	840 861	ZYL.SCHRAUBE M6X25 DIN 912 ALLEN SCREW M6X25 DIN 912 ANZUGSDREHMOMENT 6 NM TIGHTENING TORQUE 6 NM	4	
43	951 791	SCHNECKENGEWINDESCHELLE 50-70 CLAMP 50-70	1	
44	250 271	DICHTUNG GASKET	1	
45	273 971	AUSPUFFSTUTZEN KPL. EXHAUST SOCKET ASSY.	1	
46	240 071	ZYL.SCHRAUBE M8X20 DIN 912 ALLEN SCREW M8X20 ANZUGSDREHMOMENT 20 NM TIGHTENING TORQUE 20 NM	2	
47	296 161	DICHTUNGSSATZ ZYLINDER GASKET SET ASSY. CYLINDER	1	

C 899 788 LOCTITE 648 GREEN, 5 GR.

AS REQ.



B 897 651 LOCTITE 243 BLUE, 10 CC.

AS REQ.



Q 297 386 SILASTIC 732 RTV, 100 GR.

AS REQ.



EMPFOHLEN / RECOMMENDED:

XPS® KART TEC INSTANT GASKET BLACK
(SEE CHAPTER ACCESSORIES/XPS PRODUCTS)

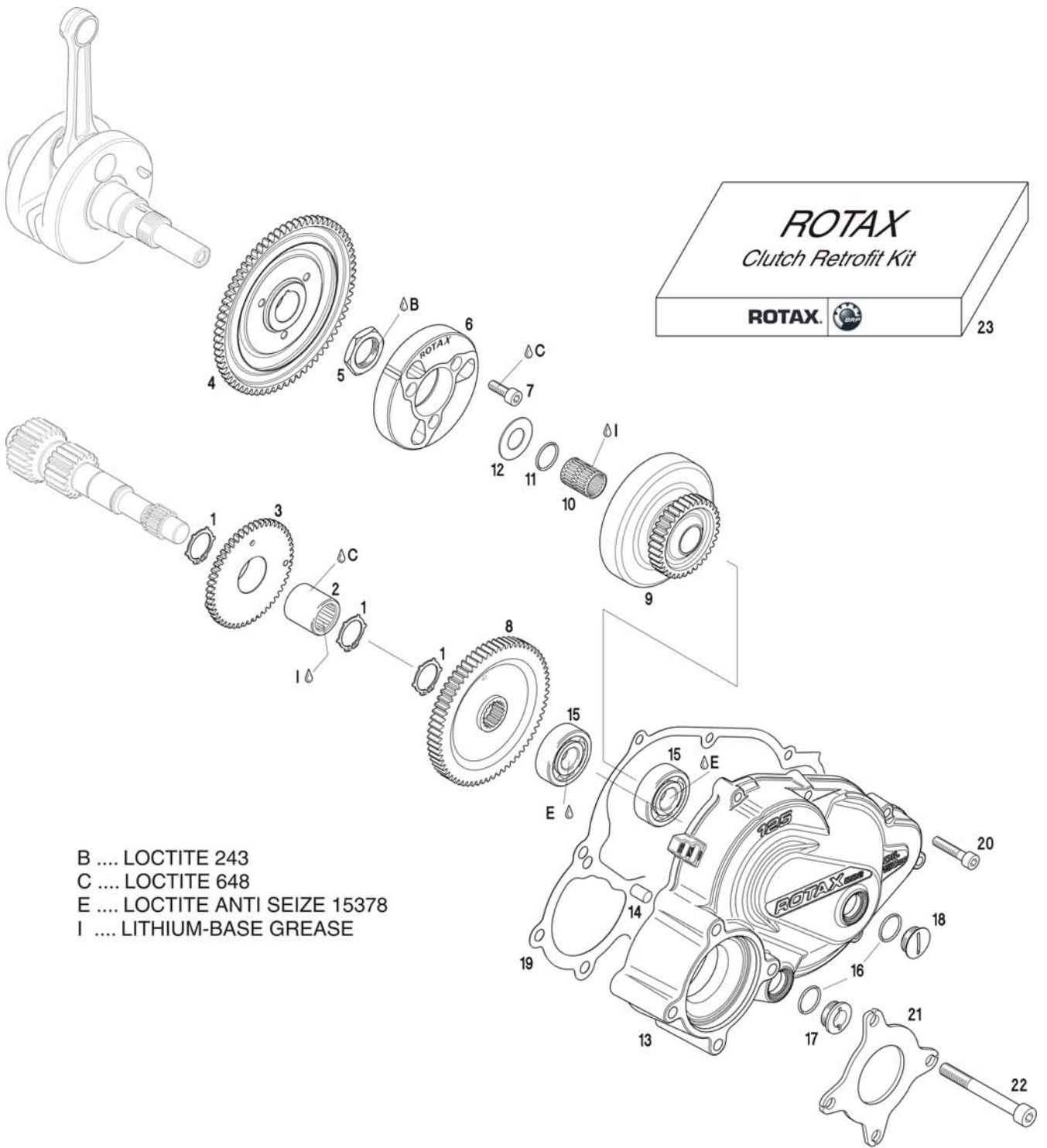











- B LOCTITE 243
- C LOCTITE 648
- E LOCTITE ANTI SEIZE 15378
- I LITHIUM-BASE GREASE



XPS® KART TEC DD2 KART GEAR OIL
 Part No: 25474 Contents: 150 ml

Chapter 3

**FLIEHKRAFTKUPPLUNG, AUSGLEICHSTRIEB, PRIMÄRTRIEB, KUPPLUNGSDECKEL
CENTRIFUGAL CLUTCH, BALANCE SHAFT DRIVER, PRIMARY DRIVE, CLUTCH COVER**

BILD-NR. ILL.NO.	TEILE-NR. PART-NO.	BEZEICHNUNG DESCRIPTION	STÜCK QTY.	BARCODE BAR CODE
1	945 664	SICHERUNGSRING DIN 983-20X1,2 RETAINING RING WITH LUG DIN 983-20X1,2	3	
2-3	635 748	AUSGLEICHSRAD 50 Z KPL. BALANCE GEAR 50 T ASSY.	1	
4	434 842	STARTERZAHNKRANZ 70 Z STARTER GEAR 70 T	1	
5	N 242 879	SK-MUTTER M22X1,5 SW30 H=6 HEX.NUT M22X1,5 H=6 ANZUGSDREHMOMENT 180 NM TIGHTENING TORQUE 180 NM	1	
6	659 905	KUPPLUNG CLUTCH	1	
7	640 901	ZYL.SCHRAUBE M6X16 DIN 912 ALLEN SCREW M6X16 DIN 912 ANZUGSDREHMOMENT 20 NM TIGHTENING TORQUE 20 NM	3	
8	N 435 541	SEKUNDAERRAD 65 Z SECONDARY GEAR 65 T OPTIONS SEKUNDAERRAD OPTIONAL SECONDARY GEAR	1	
8	N 435 542	SEKUNDAERRAD 64 Z SECONDARY GEAR 64 T OPTIONS SEKUNDAERRAD OPTIONAL SECONDARY GEAR	1	
8	N 435 543	SEKUNDAERRAD 63 Z SECONDARY GEAR 63 T OPTIONS SEKUNDAERRAD OPTIONAL SECONDARY GEAR	1	
8	N 435 544	SEKUNDAERRAD 62 Z SECONDARY GEAR 62 T STANDARD SEKUNDAERRAD STANDARD SECONDARY GEAR	1	
8	N 435 545	SEKUNDAERRAD 61 Z SECONDARY GEAR 61 T OPTIONS SEKUNDAERRAD OPTIONAL SECONDARY GEAR	1	

8	N	435 546	SEKUNDAERRAD 60 Z SECONDARY GEAR 60 T OPTIONS SEKUNDAERRAD OPTIONAL SECONDARY GEAR	1	
8	N	435 547	SEKUNDAERRAD 59 Z SECONDARY GEAR 59 T OPTIONS SEKUNDAERRAD OPTIONAL SECONDARY GEAR	1	
9		659 922	KUPPL.TROMMEL M. ANTRIEBSRAD 32Z CLUTCH W. PRIMARY DRIVE GEAR 32T	1	
9		659 923	KUPPL.TROMMEL M. ANTRIEBSRAD 33Z CLUTCH W. PRIMARY DRIVE GEAR 33T	1	
9		659 920	KUPPL.TROMMEL M. ANTRIEBSRAD 34Z CLUTCH W. PRIMARY DRIVE GEAR 34T	1	
9		659 924	KUPPL.TROMMEL M. ANTRIEBSRAD 35Z CLUTCH W. PRIMARY DRIVE GEAR 35T STANDARD	1	
9		659 926	KUPPL.TROMMEL M. ANTRIEBSRAD 36Z CLUTCH W. PRIMARY DRIVE GEAR 36T	1	
9		659 927	KUPPL.TROMMEL M. ANTRIEBSRAD 37Z CLUTCH W. PRIMARY DRIVE GEAR 37T	1	
9		659 928	KUPPL.TROMMEL M. ANTRIEBSRAD 38Z CLUTCH W. PRIMARY DRIVE GEAR 38T	1	
10		632 410	NADELKAEFIG 15X19X24 NEEDLE CAGE 15X19X24	1	
11		950 815	O-RING DIN 3771-12X2,5-N, NBR 70 O-RING DIN 3771-12X2,5-N, NBR 70	1	
12		927 057	ANLAUFSCHEIBE 15,2/25/1 THRUST WASHER 15,2/25/1	1	
13		610 642	KUPPLUNGSDECKEL CLUTCH COVER	1	
14		832 731	ZYLINDERROLLE 5X10 DIN 5402 P2 NEEDLE PIN 5X10 DIN 5402 P2	2	
15		232 291	RK-LAGER 6302 TN9/C3 BALL BEARING 6302 TN9C3/15-42-13	2	





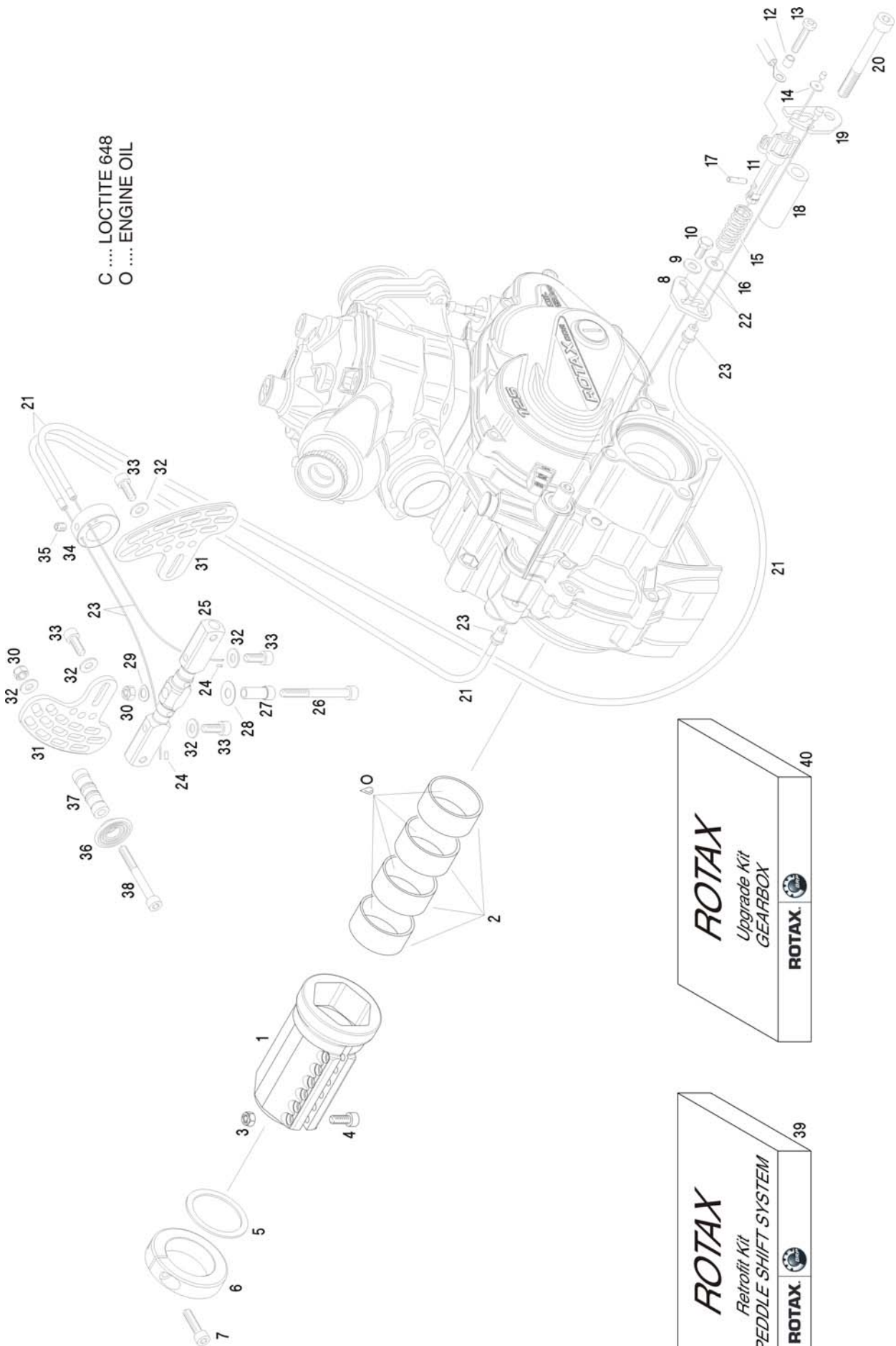





16	250 890	O-RING DIN 3771-17X1,5-N, NBR 70 O-RING DIN 3771-17X1,5-N	2	
17	240 820	OELSTANDSSCHRAUBE M18X1,5 OIL LEVEL SCREW M18X1,5	1	
18	241 800	VERSCHLUSSSCHRAUBE M18X1,5 PLUG SCREW M18X1,5	1	
19	630 512	DICHTUNG GASKET	1	
20	840 880	ZYL.SCHRAUBE M6X30 DIN 912 ALLEN SCREW M6X30 DIN 912 ANZUGSDREHMOMENT 10 NM TIGHTENING TORQUE 10 NM	6	
21	251 335	STUETZBLECH SUPPORT PLATE	1	
22	841 991	ZYL.SCHRAUBE M8X70 DIN 912 ALLEN SCREW M8X70 ANZUGSDREHMOMENT 22 NM TIGHTENING TORQUE 22 NM	4	
23	281 723	NACHRUESTSATZ KUPPLUNG 125 MAX DD2 RETROFIT KIT CLUTCH 125 MAX DD2	1	
I	897 330	LITHIUM-BASE GREASE, 250 GR.,	AS REQ.	
E	297 434	LOCTITE ANTI SEIZE 15378 50 ML.	AS REQ.	
B	897 651	LOCTITE 243 BLUE, 10 CC.	AS REQ.	
C	899 788	LOCTITE 648 GREEN, 5 GR.	AS REQ.	







C LOCTITE 648
O ENGINE OIL

















Chapter 4

**ABTRIEB, SCHALTUNG, SCHALTSEILZÜGE, LENKRADNABE
POWER TAKE OFF, SHIFTING, SHIFTING BOWDEN CABLES, STEERING WHEEL HUB**

BILD-NR. ILL.NO.	TEILE-NR. PART-NO.	BEZEICHNUNG DESCRIPTION	STÜCK QTY.	BARCODE BAR CODE
1-4	281 870	KUPPLUNGSFLANSCHSATZ COUPLING FLANGE SET	1	
1		KUPPLUNGSFLANSCH COUPLING FLANGE NICHT ALS ERSATZTEIL ERHÄLTLICH, KUPPLUNGSFLANSCHSATZ 281870 VERWENDEN! NOT AVAILABLE AS REPLACEMENT PART, USE COUPLING FLANGE SET 281870!	1	
2	233 120	LAGERHUELSE 40X44X20 PLAIN BEARING 40X44X20	4	
3	842 030	SICHERUNGSMUTTER DIN 985-M5 LOCK NUT M5	6	
4	240 186	ZYL.SCHRAUBE M5X25 DIN 912 ALLEN SCREW M5X25	6	
5	427 280	ANLAUFSCHIEBE 40/50/1,5 THRUSTWASHER 40/50/1,5	1	
6	251 740	KLEMMRING CLAMPING RING	1	
7	840 861	ZYL.SCHRAUBE M6X25 DIN 912 ALLEN SCREW M6X25 DIN 912 ANZUGSDREHMOMENT 10 NM TIGHTENING TORQUE 10 NM	4	
8	251 406	HALTEBLECH RETAINING PLATE	1	
9	845 020	FEDERSCHIEBE B6 DIN 137 SPRING WASHER B6	1	
10	240 381	SK-SCHRAUBE M6X12 DIN 933 HEX. SCREW M6X12 ANZUGSDREHMOMENT 10 NM TIGHTENING TORQUE 10 NM	1	
11		SCHALTKONTAKT SHIFT CONTACT VERWENDE SCHALTKONTAKT KPL 660538 USE SHIFT CONTACT ASSY. 660538	1	

12	974 531	KRAFTSTOFFSCHLAUCH 8 MM FUEL TUBE 8 MM	1	
13	940 431	PLASTITE-SCHRAUBE 6X25 PLASTITE SCREW 6X25	1	
14	626 770	PLASTIKSCHEIBE 3,8/14/2 WASHER 3,8/14/2	1	
15		DRUCKFEDER DM11,3 D1,4 L59,0 COMPRESSION SPRING DM11,3 D1,4 L59,0 VERWENDE SCHALTKONTAKT KPL 660538 USE SHIFT CONTACT ASSY. 660538	1	
16		ANLAUFSCHEIBE THRUST WASHER VERWENDE SCHALTKONTAKT KPL 660538 USE SHIFT CONTACT ASSY. 660538	1	
17		FIXIERSTIFT LOCATING PIN VERWENDE SCHALTKONTAKT KPL 660538 USE SHIFT CONTACT ASSY. 660538	1	
18	847 482	DISTANZHUELSE SPACER	1	
19	251 521	SCHALTKONTAKTFUEHRUNG SHIFT CONTACT GUIDANCE	1	
20	841 991	ZYL.SCHRAUBE M8X70 DIN 912 ALLEN SCREW M8X70 ANZUGSDREHMOMENT 22 NM TIGHTENING TORQUE 22 NM	1	
21		SCHALTSEILHUELLE 3,3M BOWDEN CABLE HOUSING 3,3M ERSATZ SCHALTSEIL KPL. 297134 USE BOWDEN CABLE ASSY. 297134	1	
22		SCHALTSEIL 1,9M BOWDEN CABLE 1,9M ERSATZ SCHALTSEIL KPL. 297134 USE BOWDEN CABLE ASSY. 297134	1	
23		SCHALTSEILHUELLENENDHUELSE BOWDEN CABLE FITTING ERSATZ SCHALTSEIL KPL. 297134 USE BOWDEN CABLE ASSY. 297134	2	
24		SCHALTSEILENDHUELSE BOWDEN CABLE END COVER ERSATZ SCHALTSEIL KPL. 297134 USE BOWDEN CABLE ASSY. 297134	2	

25	257 990	SCHALTWIPPE CONTROL WHIP	1	
26	240 371	ZYL.SCHRAUBE M6X60 DIN 912 ALLEN SCREW M6X60	1	
27	247 440	DISTANZHUELSE SPACER	1	
28	227 945	ANLAUFSCHIEBE 8,5/15/0,5 THRUST WASHER 8,5/15/0,5	1	
29	845 020	FEDERSCHIEBE B6 DIN 137 SPRING WASHER B6	1	
30	842 040	SICHERUNGSMUTTER DIN 985-M6 LOCK NUT M6	1	
31	657 010	SCHALTHEBEL CONTROL LEVER	2	
32	244 211	SCHIEBE 6,4 DIN 134 WASHER 6,4 DIN 134	4	
33	241 236	ZYL.SCHRAUBE M6X16 DIN 912 GLATT ALLEN SCREW M6X16 DIN 912	4	
34	651 510	SEILWIDERLAGER CABLE SUPPORT	1	
35	841 771	GEWINDESTIFT M6X8 DIN 913 SET SCREW M6X8	1	
36	657 030	DRUCKSCHIEBE THRUST WASHER OPTIONAL	N. BED AS REQ.	
37	647 190	DISTANZHUELSE SPACER OPTIONAL	N. BED AS REQ.	
38	240 371	ZYL.SCHRAUBE M6X60 DIN 912 ALLEN SCREW M6X60 OPTIONAL	N. BED AS REQ.	
39	281 850	UMRUESTSATZ SCHALTSYSTEM 125 MAX DD2 RETROFIT KIT PADDLE SHIFT S. 125 MAX DD2 DD2	1	

40 281 855 UMRUESTSATZ GETRIEBE 125 MAX DD2 1
 RETROFIT KIT GEARBOX 125 MAX DD2
 BEINHALTET / CONTAINS:
 1X HOHLWELLE
 2X NADELKÄFIG K 52X57X12
 6X LAGERHUELSE 40X44X20
 1X LOSRAD 81 Z
 1X LOSRAD 77 Z
 6X ZYL.SCHRAUBE M5X25 DIN 912
 6X SICHERUNGSMUTTER DIN 985-M5
 1X SCHALTMUFFE
 1X KUPPLUNGSFLANSCH
 1X HOLLOW SHAFT
 2X NEEDLE BEARING K 52X57X12
 6X PLAIN BEARING 40X44X20
 1X IDLE GEAR 81 Z
 1X IDLE GEAR 77 Z
 6X ALLEN SCREW M5X25 DIN 912
 6X LOCK NUT DIN 985-M5
 1X SHIFTING SLEEVE
 1X COUPLING FLANGE



O ENGINE OIL AS REQ.

C 899 788 LOCTITE 648 GREEN, 5 GR. AS REQ.





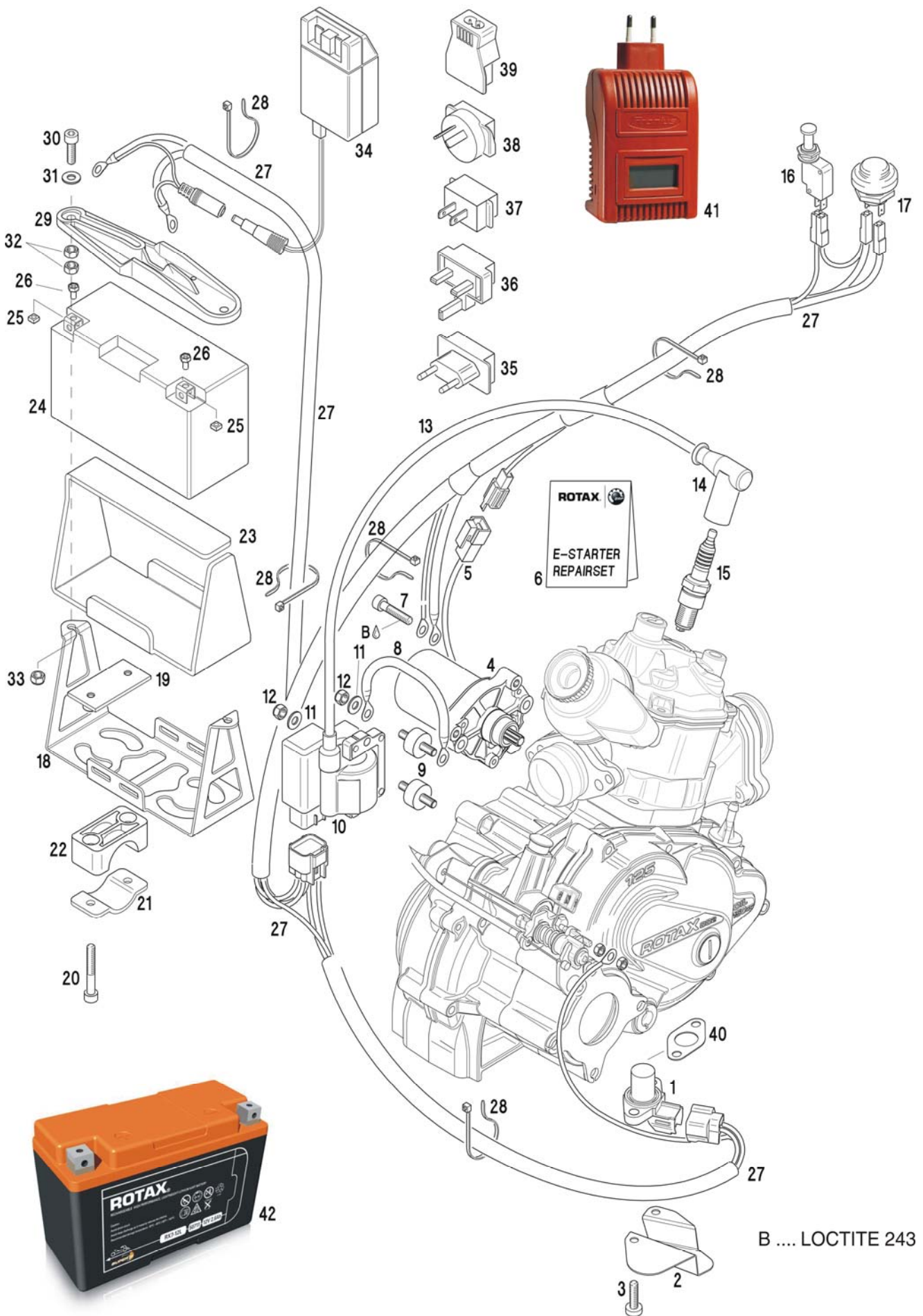

































Chapter 5

**ZÜNDANLAGE, E-STARTER, BATTERIE, BATTERIEDECKEL,
LADEGERÄT, KABELBAUM
IGNITION UNIT, E-STARTER, BATTERY, BATTERY COVER,
BATTERY CHARGER, CABLE HARNESS**

BILD-NR. ILL.NO.	TEILE-NR. PART-NO.	BEZEICHNUNG DESCRIPTION	STÜCK QTY.	BARCODE BAR CODE
1	265 560	GEBER PICK UP	1	
2	251 531	SCHUTZBLECH PROTECTION SHIELD	1	
3	440 761	LINSENFLANSCHKOPFSCHRAUBE M6X20 ALLEN SCREW W. ROUNDED FLANGE HEAD M6X20 ANZUGSDREHMOMENT 10 NM TIGHTENING TORQUE 10 NM	2	
4-5	294 802	SCHRAUBTRIEB-STARTER KPL. ELECTRIC STARTER ASSY.	1	
5	265 530	STARTERKABEL KPL. CABLE ASSY.	1	
6	281 261	REPARATURSATZ E-STARTER ERSATZZEIL REPAIR KIT (ELECTRIC STARTER) BEINHALTET / CONTAINS: 2 X SCHRAUBE M3X8 2 X DRUCKFEDER 1 X SCHLEIFKOHLE LINKS 1 X SCHLEIFKOHLE RECHTS 1 X RK-LAGER 2 X SCREW M3X8 2 X COMPRESSION SPRING 1 X CARBON BRUSH LEFT 1 X CARBON BRUSH RIGHT 1 X BALL BEARING	1	
7	840 880	ZYL.SCHRAUBE M6X30 DIN 912 ALLEN SCREW M6X30 DIN 912	2	
8	264 910	MASSELEITUNG KPL. MASS CABLE ASSY.	1	
9	660 520	RUNDPUFFER 18X15XM6 RUBBER BUFFER 18X15XM6	2	
10	266 751	ZUENDTRANSFORMATOR IGNITION COIL	1	

11	244 211	SCHEIBE 6,4 DIN 134 WASHER 6,4 DIN 134	2	
12	842 040	SICHERUNGSMUTTER DIN 985-M6 LOCK NUT M6	2	
13	864 695	ZUENDLEITUNG 360 MM IGNITION CABLE 360 MM	1	
14	866 708	WIDERSTANDSSTECKER SPARK PLUG CONNECTOR	1	
15	297 839	ZUENDKERZE 14 DENSO IW 24 ERSATZTEIL SPARK PLUG 14 DENSO IW 24 SPARE PART	1	
15	297 838	ZUENDKERZE 14 DENSO IW 27 ERSATZTEIL SPARK PLUG 14 DENSO IW 27 SPARE PART	1	
15	297 836	ZUENDKERZE 14 DENSO IW 29 ERSATZTEIL SPARK PLUG 14 DENSO IW 29 SPARE PART	1	
15	297 835	ZUENDKERZE 14 DENSO IW 31 ERSATZTEIL SPARK PLUG 14 DENSO IW 31 SPARE PART	1	
15	297 834	ZUENDKERZE 14 DENSO IW 34 ERSATZTEIL SPARK PLUG 14 DENSO IW 34 SPARE PART	1	
16	265 592	EIN-AUS ZUGSCHALTER ON-OFF PULL SWITCH	1	
17	265 580	DRUCKSCHALTER M. FEUCHT.SCHUTZ START BUTTON	1	
18	251 123	BATTERIEHALTER BATTERY CLAMP	1	
19-22	251 254	ROHRSCHELLENSETZ PIPE CLAMP SET NUR FÜR ROHRDURCHMESSER 32 MM FOR TUBE DIAMETER 32 MM ONLY	1	
21	251 360	ROHRSCHELLE PIPE CLAMP	2	
22		BATTERY CLAMP		
23	660 767	GUMMIPLATTE RUBBER PAD	1	

24-26	N	265 515	BATTERIE 12V-6,5Ah BEFUELLT BATTERY 12V-6,5Ah FILLED YUASA	1
24-26	N	265 513	BATTERIE 12V-6,5Ah UNBEFUELLT BATTERY 12V-6,5Ah UNFILLED YUASA	1
25			MUTTER M5 NUT M5	2
26			SCHRAUBE M5x SCREW M5x	2
27		266 125	KABELBAUM WIRING HARNESS	1
28		651 396	KABELBINDER 203X4,6 MM TIE WRAP 203X4,6 MM	6
29		660 221	BATTERIEDECKEL BATTERY COVER	1
30		840 886	ZYL.SCHRAUBE M6X30 DIN 6912 ALLEN SCREW M6X30 DIN 6912	2
31		244 211	SCHEIBE 6,4 DIN 134 WASHER 6,4 DIN 134	2
32		242 211	SK-MUTTER M6 DIN 934 HEX.NUT M6	4
33		842 040	SICHERUNGSMUTTER DIN 985-M6 LOCK NUT M6	2
34		265 148	BATTERIELADEGERAET BATTERY CHARGER FUER SPANNUNGEN VON 110 - 230 V FOR VOLTAGES FROM 110 - 230 V BEINHALTET 266018 ROW STECKER INCLUDES 266018 ROW PLUG	1
35		266 010	EURO-STECKER ADAPTER-EURO ADAPTER FUER / FOR "EURO" - SYSTEM	1
36		266 012	UK-STECKER ADAPTER-UK ADAPTER FUER / FOR "UK" - SYSTEM	1





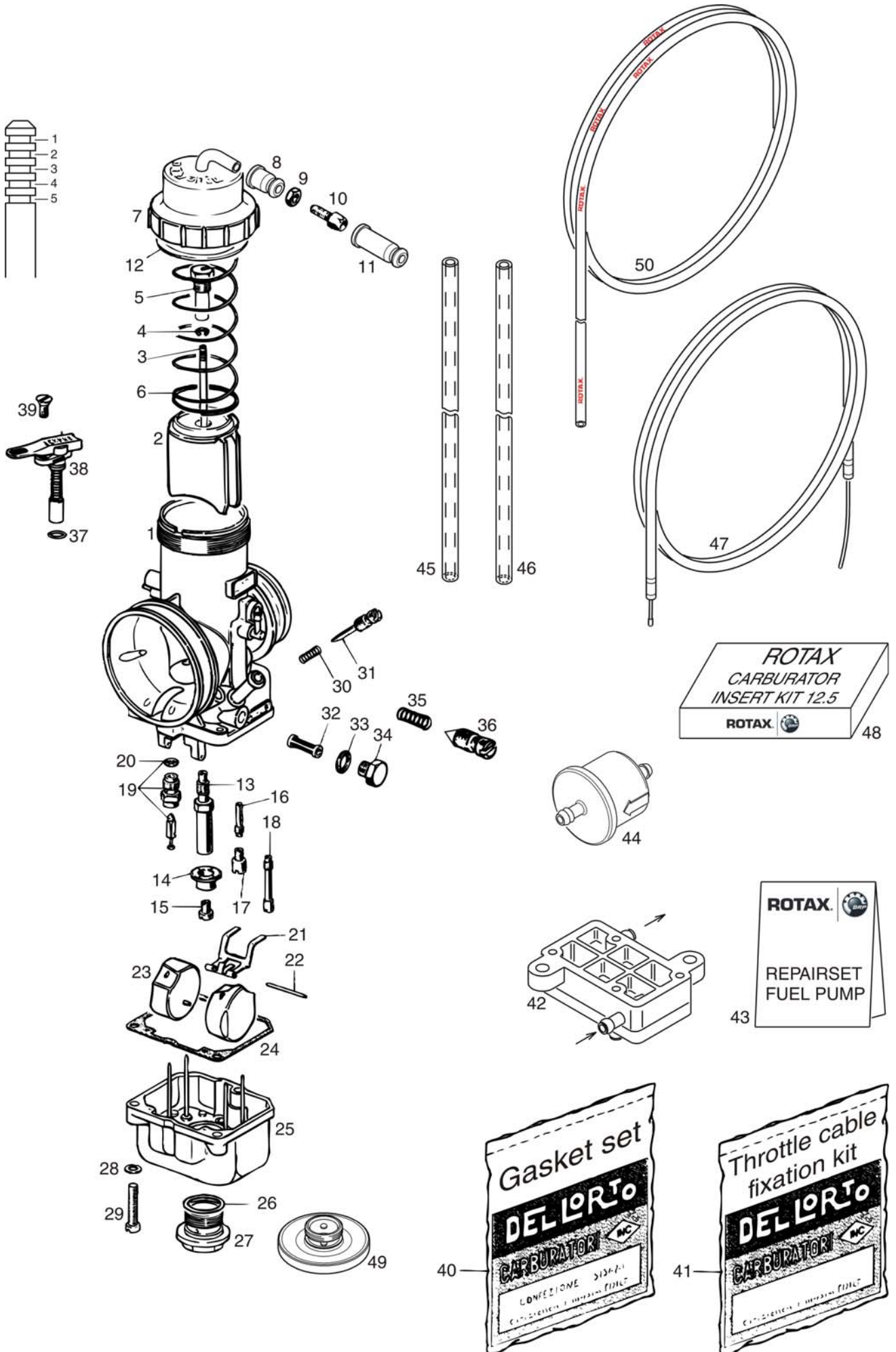



37	266 014	USA-STECKER ADAPTER-USA ADAPTER FUER / FOR "USA" - SYSTEM	1	
38	266 016	AUSTRALIEN-STECKER ADAPTER-AUSTRALIA ADAPTER FUER / FOR "AUSTRALIEN" - SYSTEM	1	
39	266 018	ROW-STECKER ADAPTER-ROW ADAPTER FUER DAS SYSTEM "REST DER WELT" ADAPTER FOR "REST OF THE WORLD" - SYSTEM	1	
40	431 500	DICHTUNG GASKET	1	
41	N 581 320	BATTERIELADEGERAET ACTIVA EASY 1202 BATTERYCHARGER ACTIVIA EASY 1202	1	
42	N 265 030	BATTERIE LITHIUM TYP 12V-2,3Ah BATTERY LITHIUM TYPE 12V-2,3Ah OPTIONAL	1	
B	897 651	LOCTITE 243 BLUE, 10 CC.	AS REQ.	













Chapter 6

**VERGASER, DICHTUNGSSATZ (VERGASER),
KRAFTSTOFFPUMPE, REPARATURSATZ (KRAFTSTOFFPUMPE),
KRAFTSTOFFSCHLAUCH, GASSEILZUG
CARBURETTOR, GASKET SET (CARBURETTOR),
FUEL PUMP, REPAIR SET (FUEL PUMP), FUEL TUBE, CABLE BOWDEN**

BILD-NR. ILL.NO.	TEILE-NR. PART-NO.	BEZEICHNUNG DESCRIPTION	STÜCK QTY.	BARCODE BAR CODE
1	295 997	DELL'ORTO-VERGASER VHSB 34 DELL'ORTO-CARBURATOR VHSB 34 BEDUESUNG „R 09808“ JETTING „R 09808“	1	
2	262 030	VERGASERSCHIEBER 40 CARBURATOR SLIDE 40	1	
3	261 190	DUESENNADEL K 27 JET NEEDLE K 27 OPTIONAL	1	
3	261 191	DUESENNADEL K 98 JET NEEDLE K 98 STANDARD	1	
4	245 630	SICHERUNGSSCHEIBE CLIP	1	
5	261 270	EINHAENGSCRAUBE NIPPLE SCREW	1	
6	239 885	SCHIEBERFEDER THROTTLE VALVE SPRING	1	
7	261 427	SCHIEBERDECKEL MIT ROHRBOGEN KPL. CARBURETOR COVER WITH BENT TUBE ASSY.	1	
8		GUMMITÜLLE KLEIN RUBBER GROMMET SMALL VERWENDE SEILEINHÄNGUNGSSATZ 268040 USE THROTTLE CABLE FIXATION KIT 268040	1	
9		SK-MUTTER M6X0,75 HEX.NUT M6X0,75 VERWENDE SEILEINHÄNGUNGSSATZ 268040 USE THROTTLE CABLE FIXATION KIT 268040	1	
10		STELLSCHRAUBE M6X0,75 ADJUSTMENT SCREW M6X0,75 VERWENDE SEILEINHÄNGUNGSSATZ 268040 USE THROTTLE CABLE FIXATION KIT 268040	1	

11		GUMMITÜLLE GROSS RUBBER GROMMET BIG VERWENDE SEILEINHÄNGUNGSSATZ 268040 USE THROTTLE CABLE FIXATION KIT 268040	1	
12		DICHTUNG GASKET VERWENDE DICHTUNGSSATZ 293834 USE GASKET SET 293834	1	
13	262 040	NADELDUESE FN 266 NEEDLE JET FN 266	1	
14	261 550	DUESENTASSE MAIN JET CUP	1	
15	281 470	HAUPTDUESENSATZ 160-162-165-168-170-172 MAIN JET KIT 160-162-165-168-170-172	1	
15	281 472	HAUPTDUESENSATZ 175-178-180-182-185-188 MAIN JET KIT 175-178-180-182-185-188	1	
15	281 474	HAUPTDUESENSATZ 190-192-195-198-200 MAIN JET KIT 190-192-195-198-200	1	
15	281 475	HAUPTDUESENSATZ 202-205-208-210 MAIN JET KIT 202-205-208-210	1	
16	261 162	LEERLAUFDUESEN EINSATZ 30 IDLE JET INSERT 30 OPTIONAL	1	
16	261 165	LEERLAUFDUESEN EINSATZ 60 IDLE JET INSERT 60 STANDARD	1	
17	261 163	LEERLAUFDUESE 30 IDLE JET 30 OPTIONAL	1	
17	261 341	LEERLAUFDUESE 60 IDLER JET 60 STANDARD	1	
18	261 895	STARTDUESE 60 STARTING JET 60	1	
19	261 880	NADELVENTIL 150 NEEDLE VALVE 150	1	
19	261 881	NADELVENTIL 200 NEEDLE VALVE 200	1	

20		DICHTUNG GASKET VERWENDE DICHTUNGSSATZ 293834 USE GASKET SET 293834	1	
21	261 290	SCHWIMMERAUFHAENGUNG FLOAT BRACKET	1	
22	229 271	STIFT FLOAT PIN	1	
23	268 030	SCHWIMMER 5,2 GR. FLOAT 5,2 GR. STANDARD	2	
23	268 031	SCHWIMMER 3,6 GR. FLOAT 3,6 GR. OPTIONAL	2	
24		DICHTUNG GASKET VERWENDE DICHTUNGSSATZ 293834 USE GASKET SET 293834	1	
25		SCHWIMMERKAMMER FLOAT CHAMBER NICHT ALS ERSATZTEIL ERHÄLTlich NOT AVAILABLE AS REPLACEMENT PART	1	
26		DICHTUNG GASKET VERWENDE DICHTUNGSSATZ 293834 USE GASKET SET 293834	1	
27	261 373	ABLASSSCHRAUBE PLUG SCREW	1	
28	845 312	HOCHSPANNRING VHZ 5 LOCK WASHER VHZ 5	3	
29	262 020	ZYL.SCHRAUBE M5X20 ALLEN SCREW M5X20	3	
30-31	268 044	LUFTREGULIERSCHRAUBENSATZ ADJUSTMENT SCREW KIT	1	
30		DRUCKFEDER COMPRESSION SPRING	1	
31		LUFTREGULIERSCHRAUBE ADJUSTMENT SCREW	1	
32-34	268 042	KRAFTSTOFFSIEBSATZ FUEL SIEVE KIT	1	

32		KRAFTSTOFFSIEB FUEL FILTER	1
33		DICHTUNG GASKET	1
34		VERSCHLUSSSCHRAUBE PLUG SCREW	1
35		DRUCKFEDER COMPRESSION SPRING NICHT ALS ERSATZTEIL ERHÄLTlich NOT AVAILABLE AS REPLACEMENT PART	1
36		EINSTELLSCHRAUBE ADJUSTMENT SCREW NICHT ALS ERSATZTEIL ERHÄLTlich NOT AVAILABLE AS REPLACEMENT PART	1
37		DICHTUNG GASKET VERWENDE DICHTUNGSSATZ 293834 USE GASKET SET 293834	1
38	261 915	CHOKERHEBEL KPL. CHOKE LEVER ASSY.	1
39	240 505	SENKSCHEIBE M4,5X10 COUNTERSUNK SCREW M4,5X10	1
40	293 834	DICHTUNGSSATZ GASKET SET FÜR DEN VERGASER FOR THE CARBURETTOR	1
41	268 040	SEILEINHAENGUNGSSATZ THROTTLE CABLE FIXATION KIT	1
42	994 483	MIKUNI-PUMPE MIKUNI-FUEL PUMP	1
43	296 165	DICHTUNGSSATZ-BENZINPUMPE GASKET SET FUEL PUMP	1
44	274 160	KRAFTSTOFFFILTER FUEL FILTER	1
45	974 529	SCHLAUCH A5x8/2500 MM TUBE A5X8/2500 MM	1
46	260 260	ENTLUEFTUNGSSCHLAUCH 180 MM AIR VENT HOSE 180 MM	1



47	297 122	GASSEILZUG KPL. CABLE BOWDEN ASSY. THROTTLE FUER DEN VERGASER FOR THE CARBURETTOR	1	
48	281 820	VERGASEREINSATZKIT 12,5 CARBURETOR INSERT KIT 12,5	1	
49	261 030	VERGASERVERSCHLUSSSCHRAUBE CARBURETOR PLUG SCREW OPTIONAL	1	
50	570910	SCHLAUCH 5X8MM 50M ROLLE ROTAX AUFDRUCK TUBE 5X8 MM / 50M ROLL ROTAX PRINTED OPTIONAL	1	

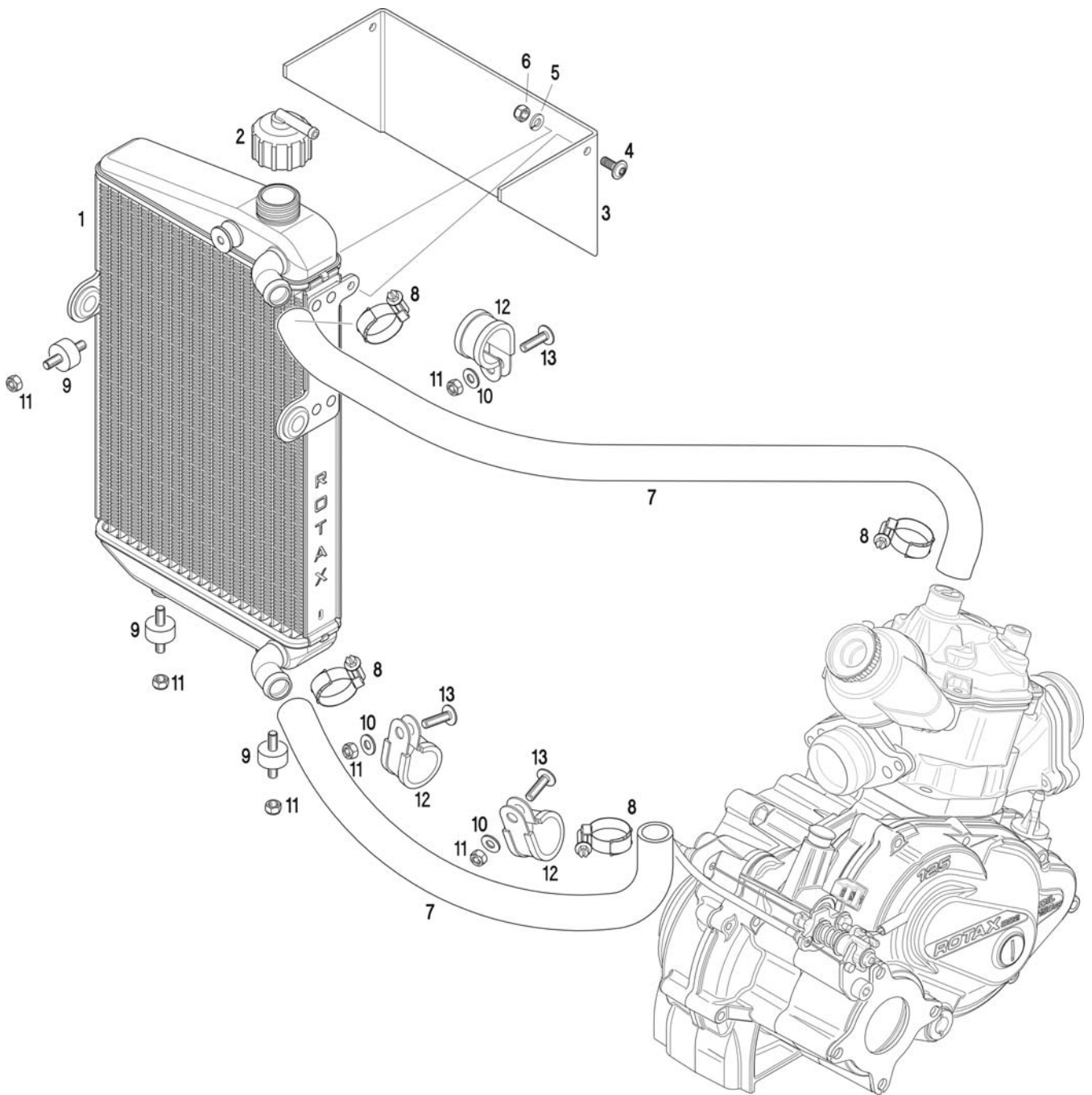

Chapter 7





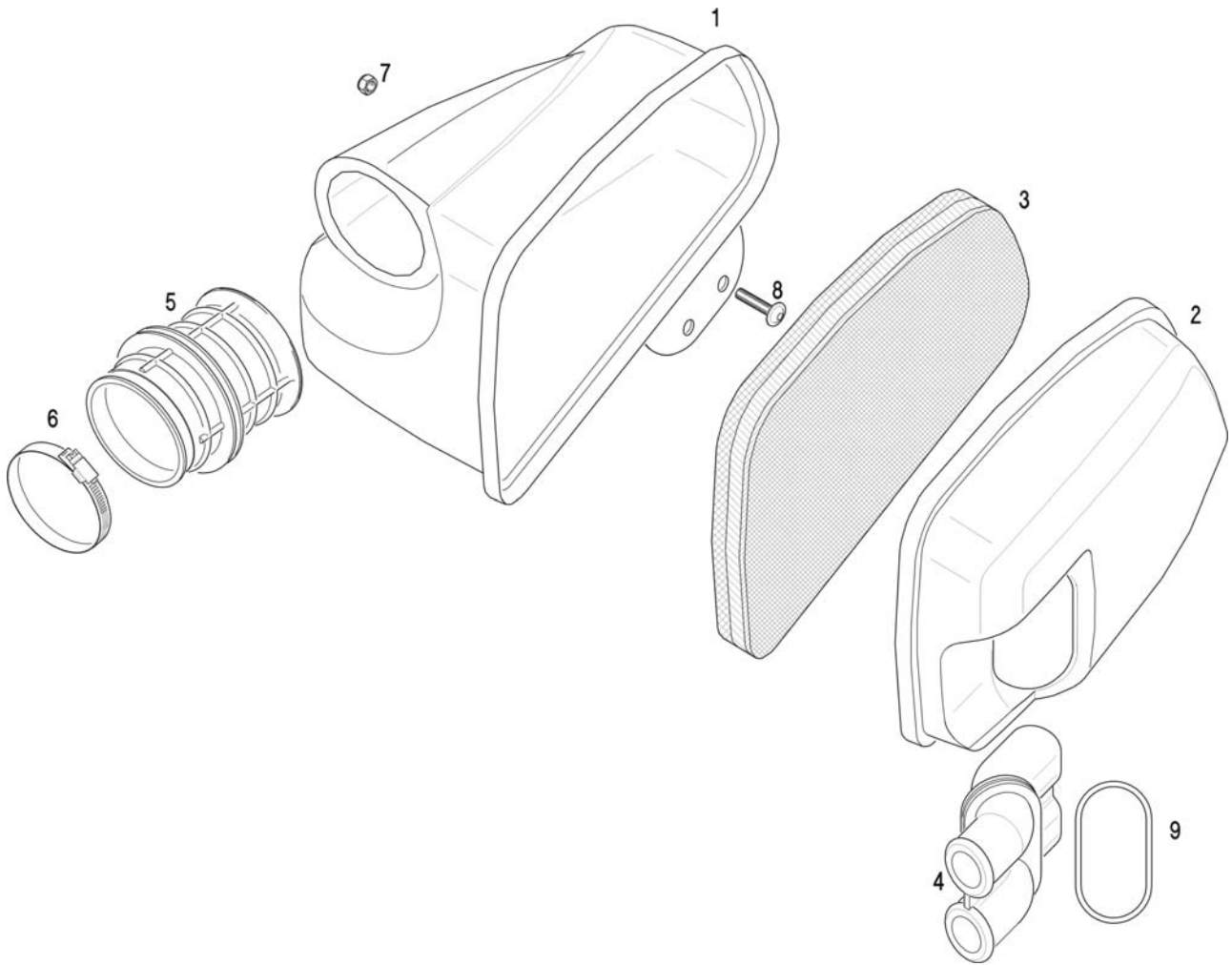



**KÜHLER, KÜHLERBEFESTIGUNG
RADIATOR, RADIATOR MOUNTING**

BILD-NR. ILL.NO.	TEILE-NR. PART-NO.	BEZEICHNUNG DESCRIPTION	STÜCK QTY.	BARCODE BAR CODE
1-6	295 926	WASSERKUEHLER KPL. RADIATOR WITH CAP ASSY.	1	
2	222 750	KUEHLERVERSCHLUSS MIT DICHTUNG RADIATOR CAP WITH GASKET 1,0 BAR	1	
3	201 224	KUEHLERKLAPPE DD2 WINDSHIELD	1	
4	440 751	LINSENFLANSCHKOPFSCHRAUBE M6X16 ALLEN SCREW W. ROUNDED FLANGE HEAD M6X16	2	
5	244 211	SCHEIBE 6,4 DIN 134 WASHER 6,4 DIN 134	2	
6	842 040	SICHERUNGSMUTTER DIN 985-M6 LOCK NUT M6	2	
7	222 741	KUEHLWASSERSCHLAUCH DIN 73411-18/650 MM COOLING-WATER HOSE NW 18	2	
8	951 870	SCHNECKENGEWINDESCHELLE 16-25 CLAMP 16-25	4	
9	660 522	RUNDPUFFER 18X15XM6 RUBBER BUFFER 18X15XM6	3	
10	244 211	SCHEIBE 6,4 DIN 134 WASHER 6,4 DIN 134	6	
11	842 040	SICHERUNGSMUTTER DIN 985-M6 LOCK NUT M6	6	
12	251 430	ROHRSCHELLE 26/M6 CABLE CLAMP 26/M6	3	
13	440 751	LINSENFLANSCHKOPFSCHRAUBE M6X16 ALLEN SCREW W. ROUNDED FLANGE HEAD M6X16	3	



Chapter 8

**ANSAUGGERÄUSCHDÄMPFER, DÄMPFERFILTER
INTAKE SILENCER, FILTER ELEMENT**

BILD-NR. ILL.NO.	TEILE-NR. PART-NO.	BEZEICHNUNG DESCRIPTION	STÜCK QTY.	BARCODE BAR CODE
1	225 012	DAEMPFERGEHAEUSE INTAKE SILENCER CASE	1	
2	225 022	DAEMPFERDECKEL INTAKE SILENCER COVER	1	
3	225 052	DAEMPFERFILTER FILTER ELEMENT	1	
4	225 041	ANSAUGDAEMPFERROHR INTAKE SILENCER TUBE	1	
5	225 031	DAEMPFERSTUTZEN CARBURETOR SOCKET	1	
6	951 791	SCHNECKENGEWINDESCHELLE 50-70 CLAMP 50-70	1	
7	842 040	SICHERUNGSMUTTER DIN 985-M6 LOCK NUT M6	1	
8	440 751	LINSENFLANSCHKOPFSCHRAUBE M6X16 ALLEN SCREW W. ROUNDED FLANGE HEAD M6X16	1	
9	650 500	O-RING DIN 3771-59,52X2,62-N, NBR 70 O-RING DIN 3771-59,52X2,62-N, NBR 70	1	

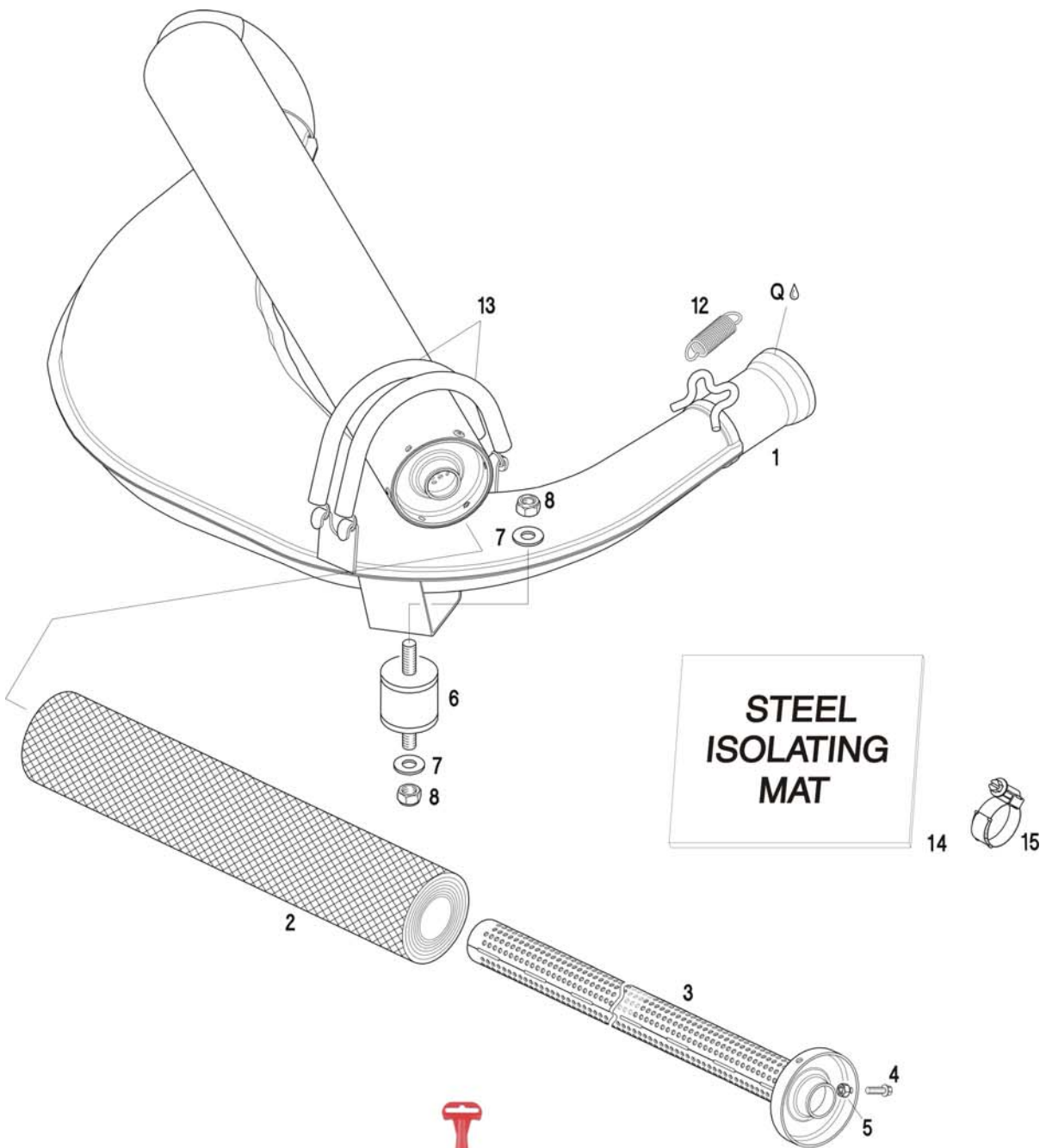

Q SILASTIC 732 RTV













EMPFOHLEN / RECOMMENDED





XPS® KART TEC INSTANT GASKET BLACK
 Part No: 25151 Contents: 200 ml



Chapter 9

**AUSPUFFANLAGE
EXHAUST SYSTEM**

BILD-NR. ILL.NO.	TEILE-NR. PART-NO.	BEZEICHNUNG DESCRIPTION	STÜCK QTY.	BARCODE BAR CODE
1	273 118	AUSPUFFTOPF KPL. EXHAUST SYSTEM ASSY., AUSFÜHRUNG MIT ZUGFEDERN (BILD-NR. 13) VERSION WITH TENSION SPRING (ILL.NO. 13)	1	
2	297 981	DAEMPFERMATTE ISOLATING MAT	1	
3	273 095	DECKEL COVER	1	
4	241 741	SK-BUNDSCHRAUBE M4X12 SW7 HEX. COLLAR SCREW M4X12 SW7 ALS ERSATZ FÜR NIETEN IM REPARATURFALL TO REPLACE RIVETS IN CASE OF REPAIR	N. BED. AS REQ.	
5	242 533	SICHERUNGSMUTTER M4 LOCK NUT M4 ALS ERSATZ FÜR NIETEN IM REPARATURFALL TO REPLACE RIVETS IN CASE OF REPAIR	N. BED. AS REQ.	
6	660 920	RUNDPUFFER 30X30XM8 RUBBER BUFFER 30X30XM8	2	
7	250 313	SCHEIBE 8,4 DIN 125 WASHER 8,4 STAINLESS STEEL	4	
8	942 030	SICHERUNGSMUTTER DIN 985-M8 LOCK NUT M8	4	
9	851 490	ROHRSCHELLE 15/M6 CABLE CLAMP 15/M6	1	
10	440 751	LINSENFLANSCHKOPFSCHRAUBE M6X16 ALLEN SCREW W. ROUNDED FLANGE HEAD M6X16	1	
11	842 040	SICHERUNGSMUTTER DIN 985-M6 LOCK NUT M6	1	
12	938 795	ZUGFEDER EBL 66 SPRING 66 MM	2	

13		238 940	ZUGFEDER TENSION SPRING	2	
14	N	297 983	DAEMPFERMATTE STAHL MIT BANDKLAMMER ISOLATING MAT STEEL WITH TIE RAP	N. BED. AS REQ.	
15	N	951880	SCHNECKENGEWINDESCHELLE 20-32 CLAMP 20-32 FÜR FIXIERUNG DER DÄMPFERMATTE FOR FIXATION OF STEEL ISOLATING MAT	N. BED. AS REQ.	
Q		297 386	SILASTIC 732 RTV, 100 GR.	1	

EMPFOHLEN / RECOMMENDED:





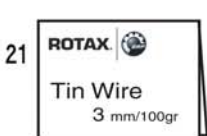
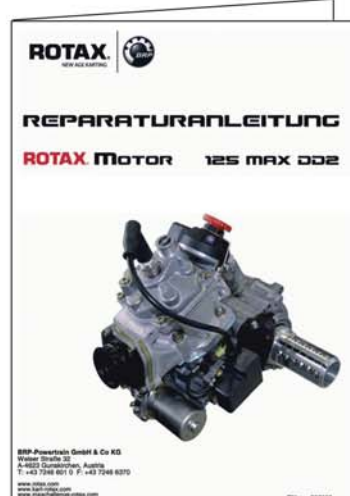
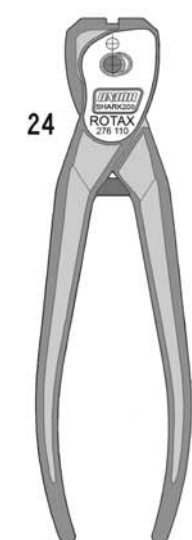
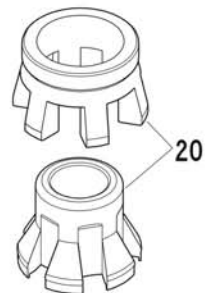
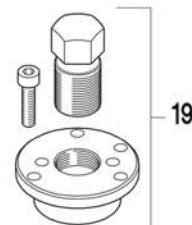
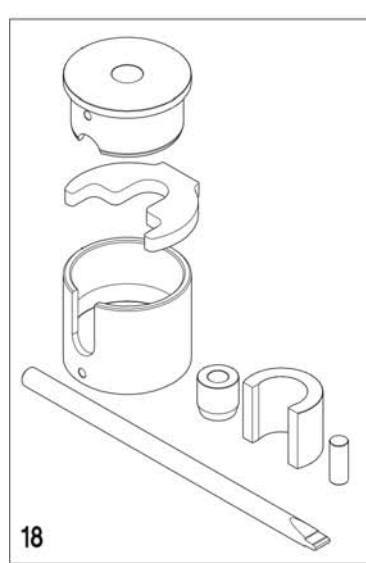
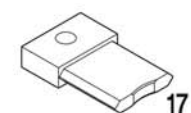
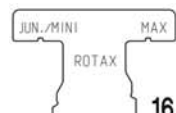
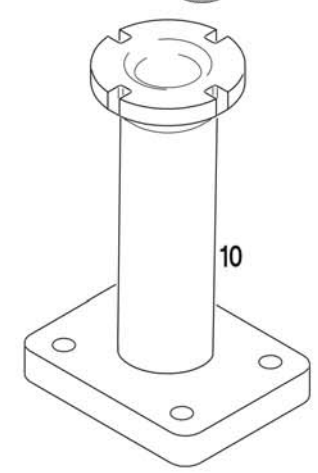
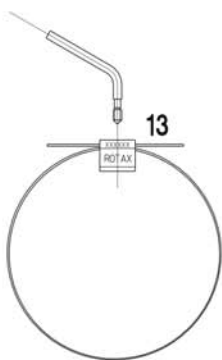
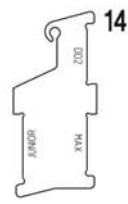
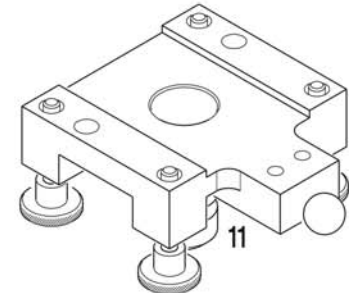
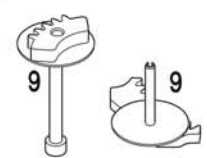
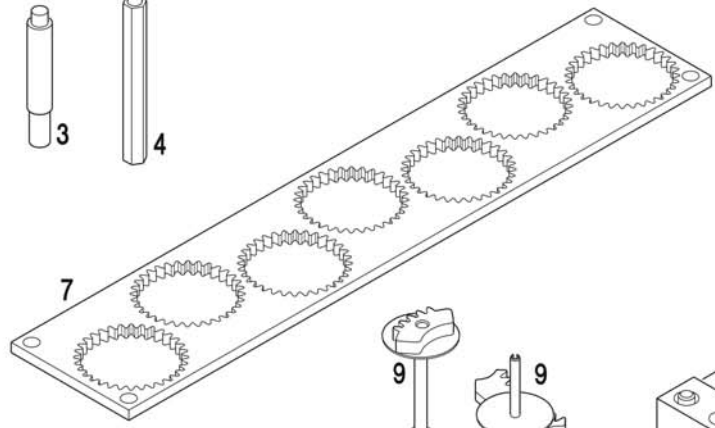
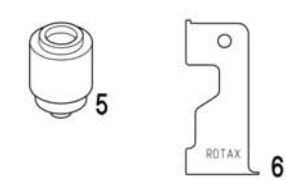
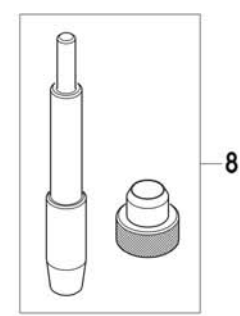
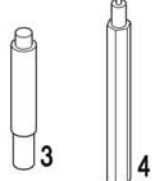
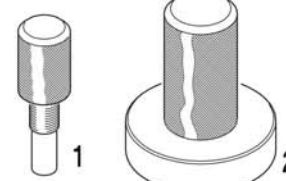
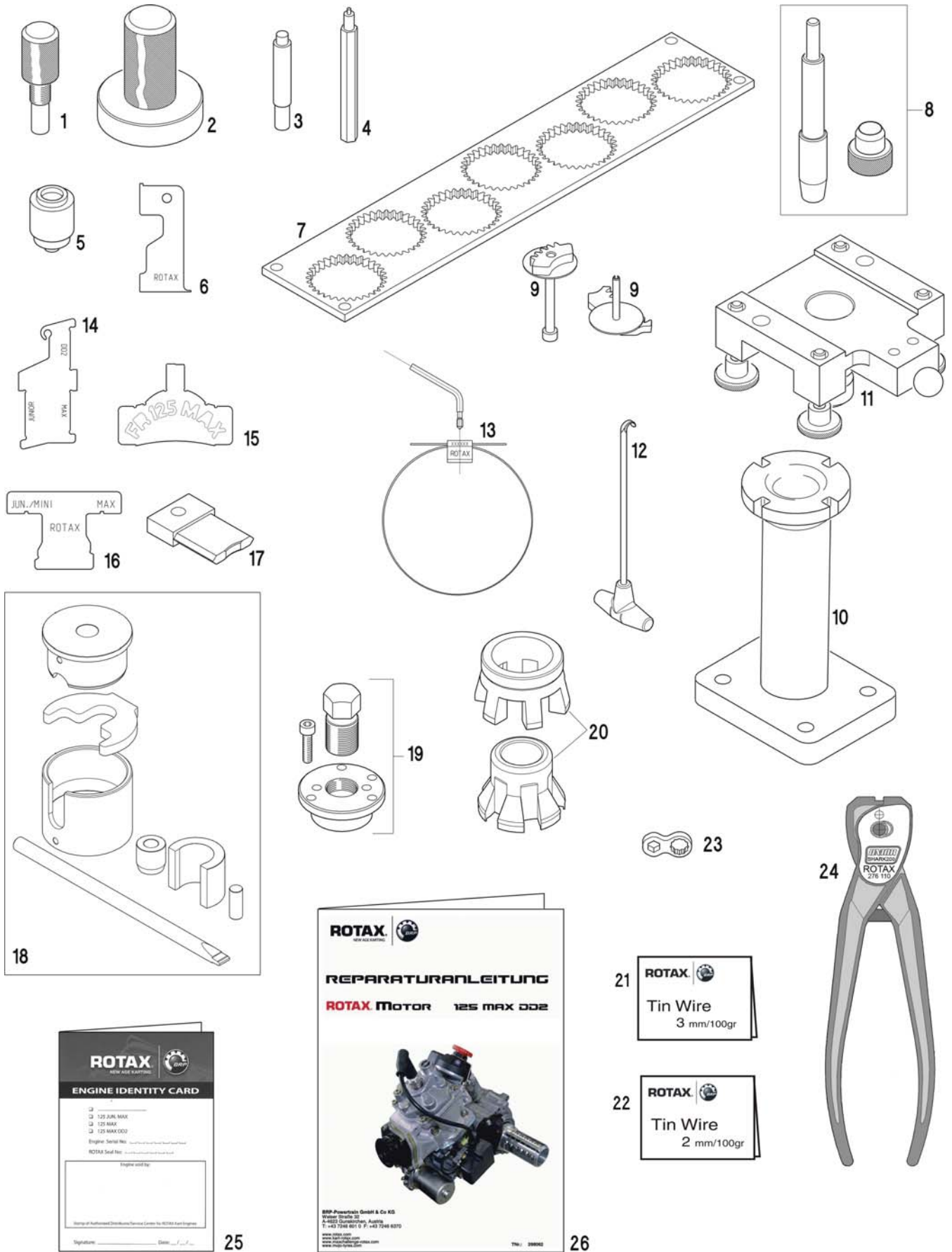



XPS® KART TEC INSTANT GASKET BLACK
(SEE CHAPTER ACCESSORIES/XPS PRODUCTS)





















Chapter 10

**WERKZEUGE
REPAIR TOOLS**

BILD-NR. ILL.NO.	TEILE-NR. PART-NO.	BEZEICHNUNG DESCRIPTION	STÜCK QTY.	BARCODE BAR CODE
1	277 380	BLOCKIERDORN FIXATION TOOL FOR CRANKSHAFT ZUM BLOCKIEREN DER KURBELWELLE TO BLOCK THE CRANKSHAFT	1	
2	676 022	MONTAGEDORN INSERTION JIG FÜR WD-RING DER HOHLWELLE FOR OILSEAL OF HOLLOW SHAFT	1	
3	676 030	MONTAGEDORN INSERTION JIG FÜR NADELHÜLSE DES E-STARTERS FOR NEEDLE BUSHING OF E-STARTER	1	
4	676 032	MONTAGEDORN INSERTION JIG FÜR SPANNHÜLSE DES WASSERPUMPENLAUFRADES FOR SLOTTED SPING PIN OF WATERPUMP IMPELLER	1	
5	676 021	MONTAGEDORN INSERTION JIG FÜR WELLENDICHTRINGE DER WASSERPUMPE FOR OIL SEALS OF WATERPUMP SHAFT	1	
6	676 230	VERGASERLEHRE CARBURETOR GAUGE	1	
7	676 192	HALTEVORRICHTUNG FIXATION TOOL NUR FÜR PRIMÄRZAHNRÄDER ALTE AUSFÜHRUNG ONLY APPLICABLE FOR OLD STYLE PRIMARY GEARS	1	
8	676 035	MONTAGEDORN INSERTION TOOL ZUR MONTAGE DER KOLBENBOLZENSICHERUNGEN FOR INSTALLATION OF PISTON PIN CIRCLIPS	1	
9	676 200	HALTEVORRICHTUNG KPL. FIXATION TOOL ASSY. ZUM BLOCKIEREN DES STARTERZAHNKRANZES TO BLOCK THE STARTER GEAR FÜR MOTOR AUSFÜHRUNGSNR. SANDCAST FÜR FOR ENGINE EXECUTION NO. SANDCAST	1	

9	676 202	FIXIERWERKZEUG KPL. DD2 FIXATION TOOL ASSY. DD2 ZUM BLOCKIEREN DES STARTERZAHNKRANZES TO BLOCK THE STARTER GEAR FÜR MOTOR AUSFÜHRUNGSNR. DIECAST FÜR FOR ENGINE EXECUTION NO. DIECAST	1	
10	877 930	LAGERBOCK TRESTLE SUPPORT	1	
11	676 052	MONTAGEPLATTE FIXING PLATE FOR ENGINE FÜR ROTAX MOTOREN TYPE FR 125 MAX / 125 MAX DD2 FOR ROTAX ENGINES TYP FR 125 MAX / 125 MAX DD2	1	
12	251 680	FEDERHAKEN SPRING HOOK FUER AUSPUFFFEDERN FOR EXHAUST SPRINGS	1	
13	297 041	ROTAX-SIEGEL MIT BARCODE ROTAX-SEAL WITH BAR CODE MIT REGISTRIERTER SERIALNUMMER NUR FÜR AUTORISIERTE VERTRIEBSPARTNER WITH REGISTERED SERIAL NO. FOR AUTHORISED DISTRIBUTORS ONLY	1	
14	277 397	KONTROLLLEHRE AUSPUFFKANALHOEHE EXHAUST PORT HEIGHT TEMPLATE	1	
15	277 390	KONTROLLLEHRE COMBUSTION CHAMBER INSERT TEMPLATE	1	
16	277 395	KONTROLLLEHRE AUSPUFFKANALHOEHE EXHAUST PORT HEIGHT TEMPLATE	1	
17	277 030	AUSPUFFSCHIEBERLEHRE EXHAUST VALVE GAUGE	1	
18	276 050	KURBELWELLEN-REPARATURVORRICHTUNG CRANKSHAFT REPAIR JIG	1	
19	276 016	ROTORABZIEHER KPL. PULLER ASSY.	1	
20	276 070	MONTAGEWERKZEUG SCHIEBERBALGFEDER ASSEMBLY TOOL BELLOW SPRING EXHAUST V.	1	
21	580 130	LOETDRAHT 2 MM-100 GR TIN WIRE 2 MM-100 GR	1	

22	580 132	LOETDRAHT 3 MM-100 GR TIN WIRE 3 MM-100 GR	1	
23	676 110	SCHLUESSELAUFSATZ SW11/SW8 ZYLINDER WRENCH ADAPTER 11/8 CYLINDER	1	
24	276 110	ROTAX SIEGEL-ZANGE ROTAX SEAL CALLIPER NUR FÜR AUTORISIERTE VERTRIEBSPARTNER FOR AUTHORISED DISTRIBUTORS ONLY	1	
25	297 240	MOTORPASS ENGINE IDENTITY CARD NUR FÜR AUTORISIERTE VERTRIEBSPARTNER FOR AUTHORISED DISTRIBUTORS ONLY	1	
26	N	REPARATURHANDBUCH 125 MAX DD2 REPAIR MANUAL 125 MAX DD2 VERFÜGBAR UNTER / AVAILABLE AT www.kart-rotax.com	1	



B



C



D



E



F



G



H



I



K

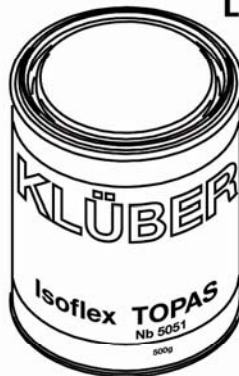

L



M



P

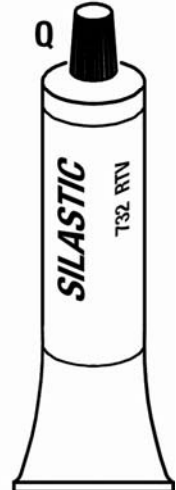

Q



R



S



T



U



W



X

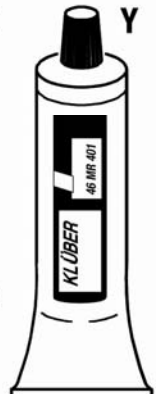

Y



Z



AA

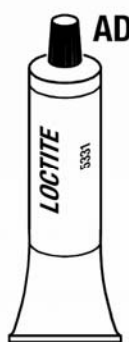

AD



AE



AF



AG



AH

Chapter 14

**SERVICE PRODUKTE
SERVICE PRODUCTS**

BILD-NR. ILL.NO.	TEILE-NR. PART-NO.	BEZEICHNUNG DESCRIPTION	STÜCK QTY.
B	897 651	LOCTITE 243 BLUE, 10 CC	AS REQ
C	899 788	LOCTITE 648 GREEN, 5 GR	AS REQ
D	899 784	LOCTITE 574 ORANGE, 50 CC	AS REQ
E	297 434	LOCTITE ANTI SEIZE 15378, 50 ML	AS REQ
F	- xxx -	LOCTITE 7063	AS REQ
G	- xxx -	LOCTITE 14486, 10 CC	AS REQ
H	897 870	FILTER OIL	AS REQ
I	- xxx -	ARCANOL	AS REQ
K	897 161	MOLYKOTE 111, 100 GR	AS REQ
L	898 351	KLUEBER ISOFLEX TOPAS NB5051, 0,5 KG	AS REQ
M	297 433	MOLYKOTE G-N, SLIDE PASTE, 100 GR	AS REQ
P	899 791	LOCTITE 5910, 50 ML	AS REQ
Q	297 386	SILASTIC 732 RTV, 100 GR	AS REQ
R	- xxx -	PU GLUE / SIKA FLEX 255	AS REQ
S	297 430	COPA SLIP	AS REQ
T	899 271	KLUEBER PETAMO GHY 133, 0,4 KG	AS REQ
U	297 906	SEALING COMPOUND, 30 ML	AS REQ
W	899 564	KLUEBER ISOFLEX TOPAS NB 52, 0,4 KG	AS REQ
X	899 511	LOCITE 518-2, 50 ML	AS REQ
Y	297 616	KLUEBE PASTE 46 MR 401, 60 GR	AS REQ
Z	899 789	LOCTITE 603 GREEN, 10 CC	AS REQ





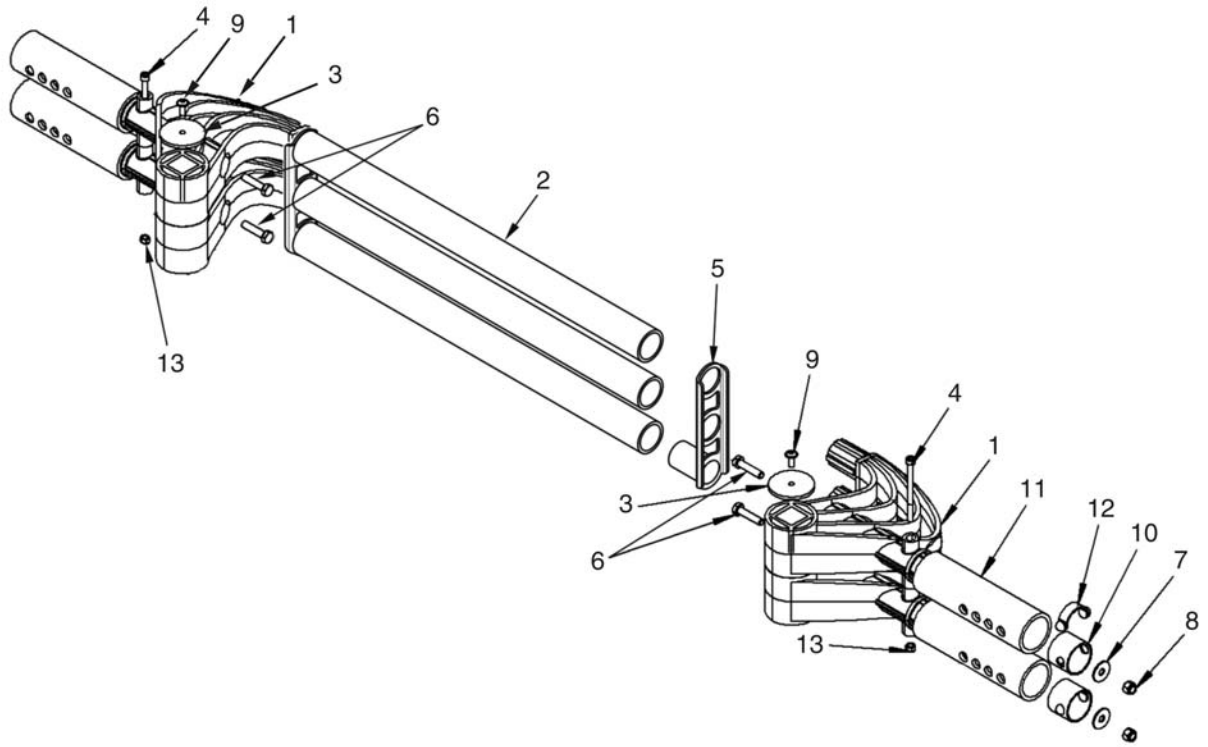









BILD-NR. ILL.NO.	TEILE-NR. PART-NO.	BEZEICHNUNG DESCRIPTION	STÜCK QTY.
AA	899 763	MOLYCOTE PG 54, 10 GR	AS REQ
AD	297 230	LOCTITE 5331 WHITE	AS REQ
AE	- xxx -	TERMALENE 699 GREASE	AS REQ
AF	- xxx -	LOCTITE 515 SEALING COMPOUND	AS REQ
AG	897186	SILICONE HEAT COMPOUND WACKER P12, 150 GR	AS REQ
AH	899 526	LOCTITE 272 RED-ORANGE, 50 ML	AS REQ





Chapter 12

**HINTERREIFEN SICHERHEITS SYSTEM
REAR TIRE PROTECTION SYSTEM**

BILD-NR. ILL.NO.	TEILE-NR. PART-NO.	BEZEICHNUNG DESCRIPTION	STÜCK QTY.	BARCODE BAR CODE
1-12, 16	281 572	AUFFAHRSCHUTZ RTPS KPL. MOD.06 REAR TIRE PROTECTION SYSTEM ASSY. MOD.06	1	
1	660 600	STOSSFAENGER REAR BUMPER	4	
2	570 060	STOSSFAENGERROHR 40X3,7X556 REAR FENDER TUBE 40X3,7X550	3	
3	570 120	DISTANZSCHEIBE 52X4 DISTANCE WASHER 52X4	2	
4	241 501	ZYL.SCHRAUBE M6X80 DIN 912 ALLEN SCREW M6X80 DIN 912	2	
5	251 760	HALTELASCHE MOUNTING LINK	2	
6	241 341	SK-SCHRAUBE M8X35 DIN 933 HEX. SCREW M8X35 DIN 933	4	
7	627 960	SCHEIBE 8/25/1,8 WASHER 8/25/1,8	4	
8	942 030	SICHERUNGSMUTTER DIN 985-M8 LOCK NUT M8	4	
9	440 751	LINSENFLANSCHKOPFSCHRAUBE M6X16 ALLEN SCREW W. ROUNDED FLANGE HEAD M6X16	2	
10	233 130	GLEITHUELSE ANTIFRICTION BUSHING	4	
11	570 050	ANLAUFROHR 50X4,6X170 TYRE PROTECTION ROLLER 50X4,6X170	4	
12	570 080	FEDERELEMENT SPRING ELEMENT	4	
13	842 040	SICHERUNGSMUTTER DIN 985-M6 LOCK NUT M6	4	



1



2







3



4

Chapter 13

ZUBEHÖR & XPS®-PRODUKTE
ACCESSORIES & XPS®-PRODUCTS

BILD-NR. ILL.NO.	TEILE-NR. PART-NO.	BEZEICHNUNG DESCRIPTION	STÜCK QTY.	BARCODE BAR CODE
1	581 320	BATTERIELADEGERAET ACTIVA EASY 1202 BATTERYCHARGER ACTIVIA EASY 1202 EU CONNECTORS ONLY MUST NOT BE USED IN JAPAN	1	
2	N 265 030	BATTERIE LITHIUM TYP 12V-2,3Ah BATTERY LITHIUM TYPE 12V-2,3Ah	1	
3	581 380	STUNDENZAEHLER DIGITAL KARTECH DIGITAL HOURMETER KARTTECH	1	
4	276 100	REIFENDRUCKMESSGERAET DIGITAL DIGITAL TIRE PRESSURE GAUGE	1	



XPS® KART TEC 2 Stroke Synthetic Oil
Part No: 297460 Contents: 946 ml (1 U.S. QT)

XPS® KART TEC SYNTHETIC CHAIN SPRAY
Part No: 25108 Contents: 500 ml



XPS® KART TEC CERAMIC MULTI SPRAY
Part No: 25405 Contents: 500 ml

XPS® KART TEC WHITE CHAIN SPRAY
Part No: 25112 Contents: 500 ml



XPS® KART TEC CARBURETTOR CLEANER
Part No: 25311 Contents: 500 ml

XPS® KART TEC BRAKE CLEANER
Part No: 25315 Contents: 500 ml



XPS® KART TEC HELMET VISOR CLEANER
Part No: 25404 Contents: 200 ml

XPS® KART TEC DD2 KART GEAR OIL
Part No: 25474 Contents: 150 ml



XPS® KART TEC BRAKE FLUID DOT 4
Part No: 25475 Contents: 250 ml

XPS® KART TEC KART GEAR OIL
Part No: 25113 Contents: 100 ml



**XPS® KART TEC KART CLEANER
+ PRESSURE SPRAYER**
Part No: 25501 Contents: 5 Ltr.
Part No: 25935 Capacity: 1,5 Ltr

XPS® KART TEC INSTANT GASKET BLACK
Part No: 25151 Contents: 200 ml





